



STAIR & RAILING PRODUCTS BY

 **HOUSE OF FORGINGS**



353 Greens Landing Dr.
Houston, Texas 77038
Toll Free 866.443.4848 Fax 281.443.1133
www.houseofforgings.net

Please contact us for more detailed information
or for a listing of suppliers near you.

Edition 001-A

Whether your customer is a homeowner, retailer, or homebuilder, the timeless design and quality craftsmanship of House of Forgings' stair and railing products will attract the attention of the most discerning eye.

Our impeccably crafted styles are originally designed in partnership with our Italian studio and created with the sense of pride in workmanship that can only be found in an employee owned company. We fashion stairs and railings from the finest materials available so that what you provide to your clients is unsurpassed in style, uncompromising in quality, and unmatched in elegance.

We manufacture over 2,000 active SKUs in over 200,000 square feet of warehouse space with a national distribution network that ships to you in under 24 hours. No one else comes close to the brilliantly executed design, construction, and service you'll experience only at House of Forgings.



Table of Contents

POWDER COATED & STAINLESS STEEL	3-63
Finishes & Patinas	4-5
Stainless Steel Cable Railing	6-9
Horizontal Bar Railing	10-15
Soho	16-17
Foundation	18-19
Mega	20-21
Wentworth	22-25
Aalto	26-29
Tuscan	30-35
Monte Carlo	36-37
Designer	38-39
Stainless	40-41
Santa Fe	42-43
Gothic	44-45
Round	46-49
Versatile	50-53
Ribbon	54-57
Twist	58-61
Accessories	62-63
FORGED PANELS	64-85
Rebecca	65-67
Tuscany	68-71
Seville	72-73
Milano	74-76
Bordeaux	78-81
Regency	82-85
WOOD	86-100
Newels & Balusters	88-93
Handrail & Fittings	94-95
Treads	96-97
Starter Steps	98
Lumber & Plywood	98
Moulding	99
Accessories	100
AXIA STAIR & RAILING SYSTEMS	101
SALES & MARKETING SUPPORT	102-103
CUSTOM IRON FABRICATION & FINISHING	104

Powder Coated & Stainless Steel

**House of Forgings
is the benchmark in
the stair and railing
industry, offering an
unsurpassed
selection of quality
products and
expert service.**

Our vast selection of products will meet the needs of even the most discerning customers. Whether selecting a powder coated finish or stainless steel, our newels, balusters and accessories will compliment a broad range of architectural styles.

STAIR & RAILING PRODUCTS BY



**HOUSE OF
FORGINGS**

Finishes & Patinas



SATIN BLACK (STB)



ASH GREY (AG)

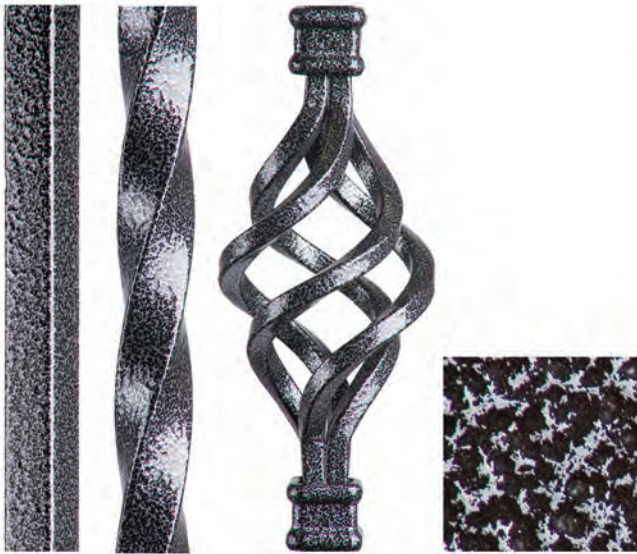

SILVER VEIN (SP)



COPPER VEIN (CV)



OIL RUBBED BRONZE (ORB)



OIL RUBBED COPPER (ORC)



SATIN CLEAR (SC)

This is a clear finish over RAW/unfinished iron, variations in surface color may occur.



DORADO GOLD (GD)



STAINLESS STEEL (Satin Polish)



BRASS (Satin Polish)

Passivated to minimize tarnishing, use gloves when handling.

House of Forgings provides an unsurpassed selection of designs in the highest quality powdercoated finishes available. Our hand applied patinas enhance the lines and hammered detail of each unique piece. As interior design trends move forward, count on us to carry the latest styles & finishes.

THESE FINISHES HAVE BEEN PROFESSIONALLY PHOTOGRAPHED WITH THE HIGHEST INTEGRITY. OUR GOAL IS TO PRODUCE THE MOST REALISTIC MATCH TO THE ACTUAL FINISHES, HOWEVER SOME SLIGHT VARIANCES MAY OCCUR. All images are the sole property of House of Forgings, LLC. and cannot be copied or reproduced without written permission.

— Stainless Steel —
Cable Railing



Red Oak 4000 Newels, 6084 Handrail with stainless round bar bracket (shown)

Create the ideal modern aesthetic by combining stainless steel cable and rich oak. The expansive views allowed for by cable make it ideal for balconies as well as staircases.



SWAGED CABLE INFILL KITS FOR WOOD OR METAL POSTS

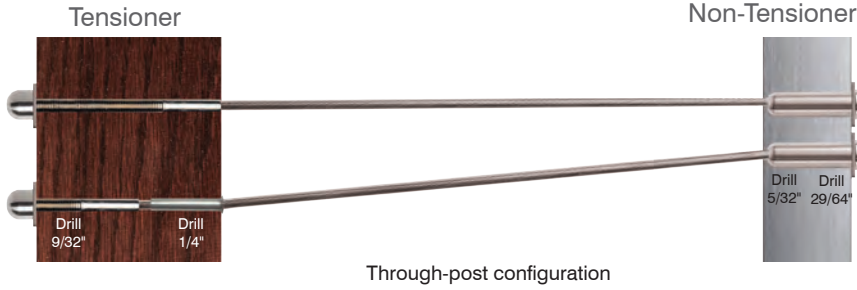

Through-post configuration

Outside to outside
Level/balcony or angle/stair
Steel or wood posts

HFC18.102-5	5'	.15 kgs (.331 lbs)
HFC18.102-10	10'	.227 kgs (.5 lbs)
HFC18.102-15	15'	.303 kgs (.669 lbs)
HFC18.102-20	20'	.383 kgs (.844 lbs)
HFC18.102-25	25'	.549 kgs (1.2 lbs)

Pre-assembled kit includes fittings and factory swaged cable in lengths 5'-25'

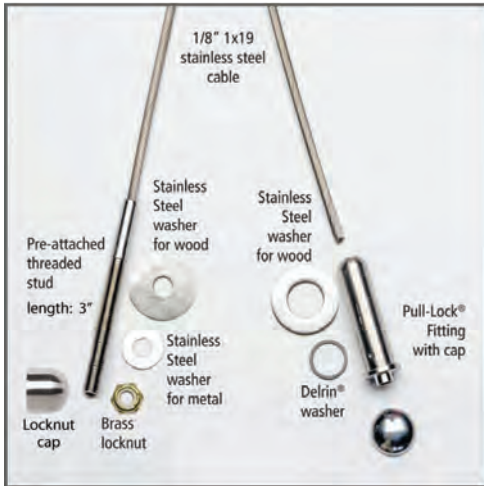

Included in kit



**MINIMUM BREAKING STRENGTH - Cable Diameter 1/8" = 1,780 lbs.
1X19 STRAND TYPE 316 STAINLESS STEEL CABLE**

1 x 19 Cable - 1/8" Diameter



AISI 316

Cable Cutter



HFC18.CUTTER

Cable cut-off wheel



HFC18.WHEEL

Used to cut cable flush with the end of Pull-Lock fittings, and to cut excess threads of stud. Includes mandrel and two cut-off wheels.

Drill Kit
Metal Post



AX00.070.635

Drill Kit
Wood Post



AX00.070.630

EASY AS 1-2-3

- 1. What posts are you using? Wood or metal?**
- 2. Measure your level and stair runs, calculate number of level and stair fittings.**
- 3. Add up tensioners and non-tensioners, then calculate total cable footage (plus 5%).**

Push-Lock® Fittings

Push-Lock fittings do not require any special tools for installation. Simply push the cable into the fitting and it locks.

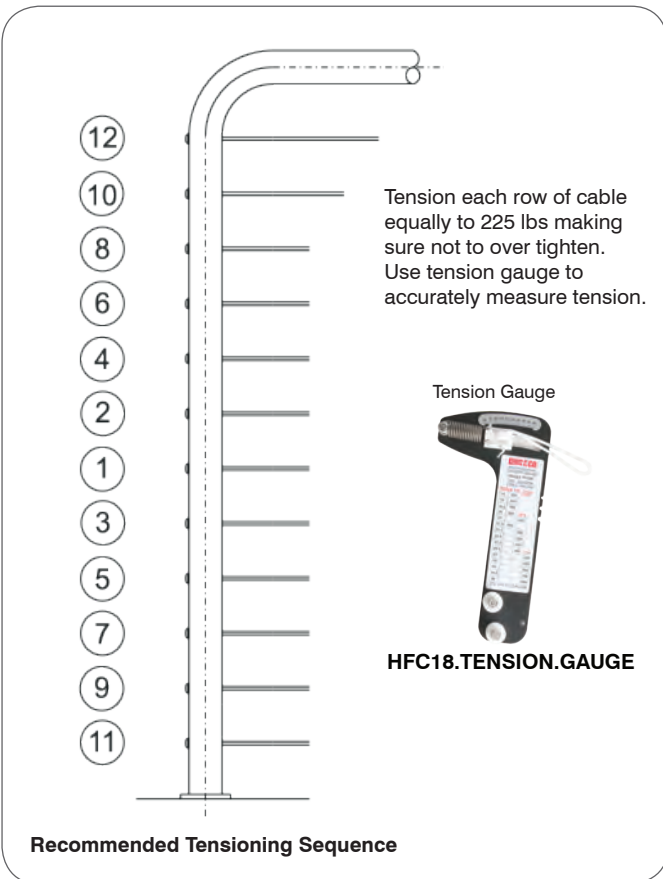
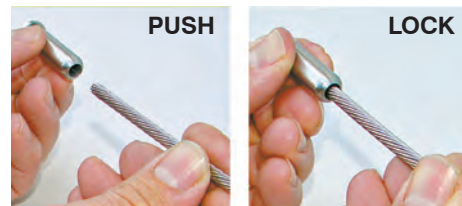

Recommended Tensioning Sequence

SWAGELESS CABLE INFILL FOR WOOD OR METAL POSTS

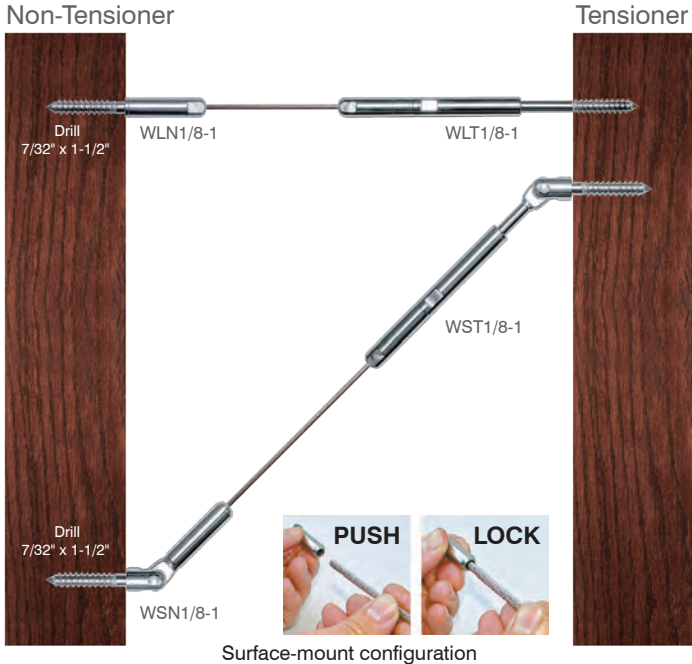

Surface-mount configuration

Inside to inside Level/balcony or angle/stair Wood posts

For use with 1/8" cable

WLN1/8-1	Wood Level Non Tensioner	.04 kgs (.092 lbs)
WLN1/8-10	Wood Level Non Tensioner(10 pack)	.31 kgs (.693 lbs)
WLT1/8-1	Wood Level Tensioner	.07 kgs (.173 lbs)
WLT1/8-10	Wood Level Tensioner(10 pack)	.68 kgs (1.5lbs)
WSN1/8-1	Wood Stair Non Tensioner	.06 kgs (.135 lbs)
WSN1/8-10	Wood Stair Non Tensioner(10 pack)	.5 kgs (1.12 lbs)
WST1/8-1	Wood Stair Tensioner	.09 kgs (.217 lbs)
WST1/8-10	Wood Stair Tensioner(10 pack)	.88 kgs (1.94 lbs)

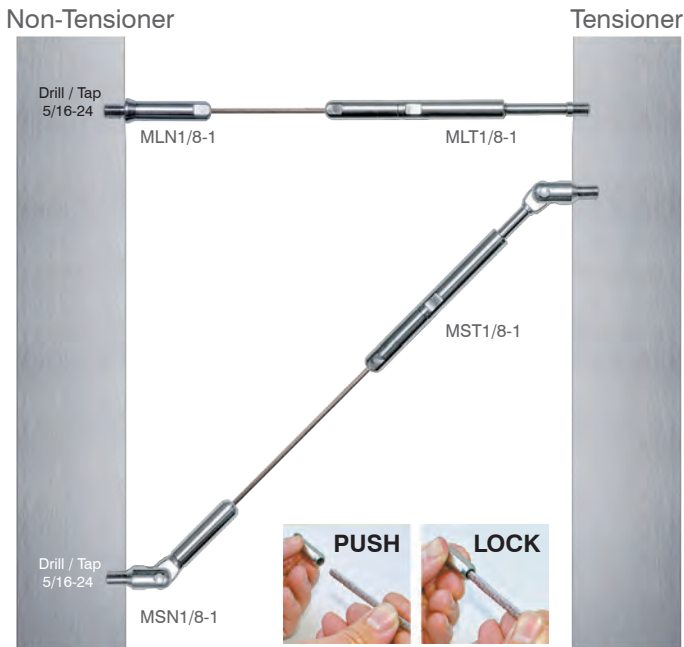

Surface-mount configuration

Inside to inside Level/balcony or angle/stair Metal posts

For use with 1/8" cable

MLN1/8-1	Metal Level Non Tensioner	.04 kgs (.087 lbs)
MLN1/8-10	Metal Level Non Tensioner(10 pack)	.29 kgs (.638lbs)
MLT1/8-1	Metal Level Tensioner	.07 kgs (.158 lbs)
MLT1/8-10	Metal Level Tensioner(10 pack)	.61 kgs (1.349 lbs)
MSN1/8-1	Metal Stair Non Tensioner	.05 kgs (.118 lbs)
MSN1/8-10	Metal Stair Non Tensioner(10 pack)	.6 kgs (1.349 lbs)
MST1/8-1	Metal Stair Tensioner	.09 kgs (.202 lbs)
MST1/8-10	Metal Stair Tensioner(10 pack)	.81 kgs (1.793 lbs)

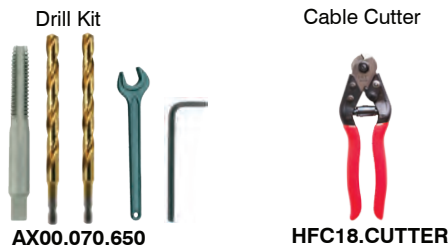

UTCABLE100-4	100' coil - 1/8" 1X19 type 316 S/S cable	2.07 kgs (4.56 lbs)
UTCABLE500-4	500' spool - 1/8" 1X19 type 316 S/S cable	10.02 kgs (22.1 lbs)

1x19 Cable(1/8" 316)

**MINIMUM BREAKING STRENGTH - Cable Diameter 1/8" = 1,780 lbs.
1X19 STRAND TYPE 316 STAINLESS STEEL CABLE**



SATIN BLACK

HFSTB5.1.1

Powder Coated Tubular Round Bar 5/8" Dia. x 8'

OIL RUBBED BRONZE **HFORB5.1.1**

Powder Coated Tubular Round Bar 5/8" Dia. x 8'

ASH GREY

HFAG5.1.1

Powder Coated Tubular Round Bar 5/8" Dia. x 8'

COASTAL WHITE

HFWHT5.1.1

Powder Coated Tubular Round Bar 5/8" Dia. x 8'

NEW!

STAINLESS STEEL

HFSS5.1.1

304 Grade Stainless Steel Round Bar 5/8" Dia. x 8'

Our tubular bar is made with superior 12 gauge(2 mm / 5/56") stock for minimal deflection

HORIZONTAL
RAILING

Now available exclusively from House of Forgings, powder coated and stainless steel tubular round bars. These sleek 5/8" bars are available in a convenient 8' length, ideal for installation and affordable shipping. Mix and match them with our exclusive components for a look that is completely custom and uniquely you.



Ash Grey (shown)



Satin Black (shown)



Stainless Steel (shown)

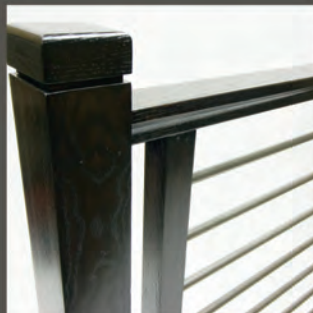

Ash Grey (shown)



Satin Black (shown)

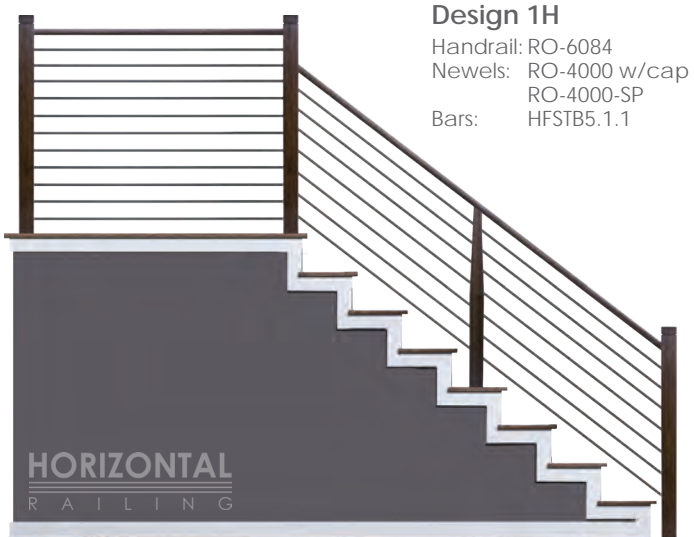

Design 1H
 Handrail: RO-6084
 Newels: RO-4000 w/cap
 RO-4000-SP
 Bars: HFSTB5.1.1

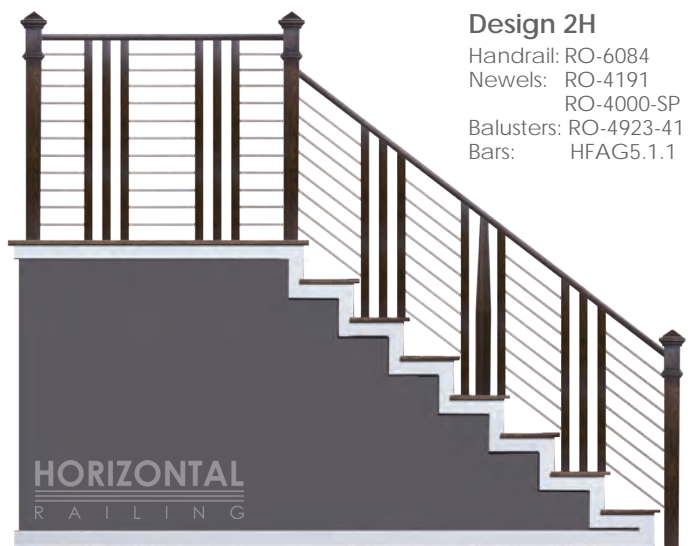

Design 2H
 Handrail: RO-6084
 Newels: RO-4191
 RO-4000-SP
 Balusters: RO-4923-41
 Bars: HFAG5.1.1



Design 3H
 Handrail: RO-6084
 Newels: RO-4000
 Bars: HFAG5.1.1

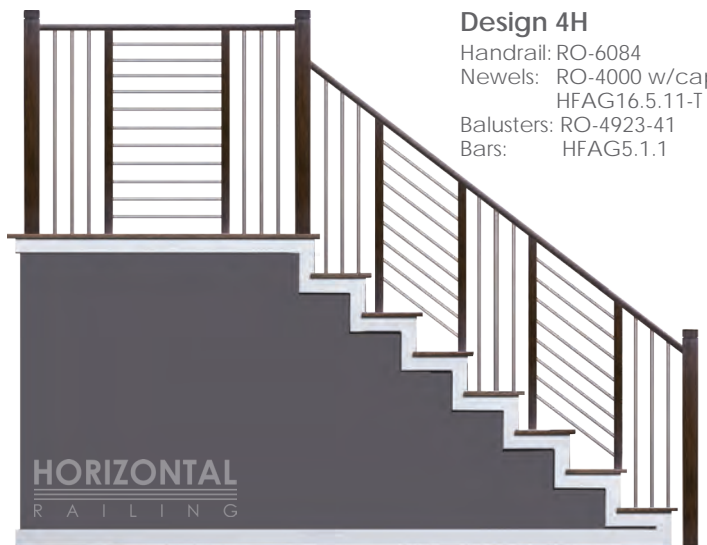

Design 4H
 Handrail: RO-6084
 Newels: RO-4000 w/cap
 HFAG16.5.11-T
 Balusters: RO-4923-41
 Bars: HFAG5.1.1



Design 5H
 Handrail: RO-6084
 Newels: RO-4592-PLAIN
 RO-4592-SP
 Balusters: RO-4923-41
 Bars: HFSTB5.1.1

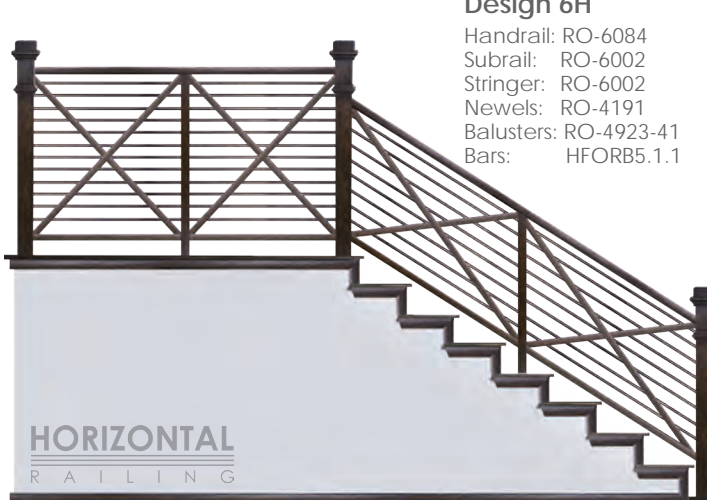

Design 6H
 Handrail: RO-6084
 Subrail: RO-6002
 Stringer: RO-6002
 Newels: RO-4191
 Balusters: RO-4923-41
 Bars: HFORB5.1.1



Design 1FK

Handrail: RO-6084

Newels:

Starting: RO-5400

Intermediate: RO-4400

Bars: HFSTB5.1.1

Design 2FK

Handrail: RO-6084

Newels:

Starting: RO-5900

Intermediate: RO-4900

Bars: HFSTB5.1.1



Design 3FK

Handrail: RO-6084

Newels:

Starting: RO-5000

Shown w/ optional COVE CAP-5000

Intermediate: RO-4000

Shown w/ optional COVE CAP-4000

Bars: HFSTB5.1.1



— Stainless Steel —
Cable Railing

HORIZONTAL
RAILING

ACCESSORIES

Box Newels

Non removable caps
Stocked in Red Oak and White Oak



Routed Newels

Non removable caps
Stocked in Red Oak and White Oak



Blank Newels

Optional caps available
Stocked in Red Oak and White Oak



Blank Newel Caps Available for: 3-1/4" and 5-1/2" blank newels
Stocked in Red Oak and White Oak - Sold separately



3-1/4" Square Newels	SQUARE CAP-4000 HT. 1-3/4" W= 3-1/4"	PYRAMID CAP-4000 HT. 1-9/16" W= 3-1/4"	STACKED CAP-4000 HT. 2-1/4" W= 3-1/4"	COVE CAP-4000 HT. 2-1/2" W= 4-5/8"
5-1/2" Square Newels	SQUARE CAP-5000 HT. 2" W= 5-1/2"	PYRAMID CAP-5000 HT. 1-5/8" W= 5-1/2"	STACKED CAP-5000 HT. 2-3/4" W= 5-1/2"	COVE CAP-5000 HT. 2-7/8" W= 6-7/8"

Newel Bases

Stocked in Red Oak and White Oak
Sold separately



Modern Handrail

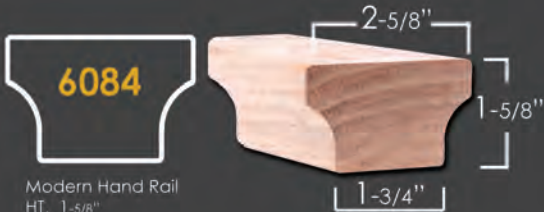

6084

Modern Hand Rail
HT. 1-5/8"
W. 2-5/8"

6084 Straight Rail
6084-B Bending Rail

no fittings available



6002

Modern Hand Rail
HT. 1-5/8"
W. 2-3/4"

6002 Straight Rail
6002-B Bending Rail

no fittings available



6060

Modern Hand Rail
HT. 1-1/16"
W. 2"

6060 Straight Rail

no fittings available

* All wood parts stocked in Red Oak and

ROUND STAINLESS NEWEL

HF17.1.2-T
Ends : 1-3/16" Rd.
Height: 47"
Wt. 5.7 lbs.
TUBULAR

ROUND NEWEL

HF 16.5.11
Ends : 1-3/16" Rd.
Height: 48"
Wt. 19 lbs.
SOLID

HF 16.5.11-T
Ends : 1-3/16" Rd.
Height: 48"
Wt. 5.7 lbs.
TUBULAR



(Newels or bars can be cut to length for handrail brackets)

Wall Mount Handrail Bracket



mounting hardware included



HF17.4002
Stainless Steel(304)
HT. 2-1/2"
Base = 1-1/2" x 2"
Extends 3-1/4" off wall
ADJUSTABLE

HFSTB17.4002
Satin Black
HT. 2-1/2"
Base = 1-1/2" x 2"
Extends 3-1/4" off wall
ADJUSTABLE

Newel Mount Handrail Bracket



mounting hardware included



HF17.4001
Stainless Steel(304)
HT. 1-3/4"
Base = 1-1/2" sq.
ADJUSTABLE

HFSTB17.4001
Satin Black
HT. 1-3/4"
Base = 1-1/2" sq.
ADJUSTABLE

Cable Gripping Pliers



HFC18.PLIERS

Cable Cutter



HFC18.CUTTER

Insert Tube



Length: 1-1/2"
HFC18.TUBE

Release Key



HFC18.KEY

Cable Cut-off Wheel



HFC18.WHEEL



Lag Bolt Driver



For use with WLNI/8-1 swageless cable fitting

DRIVER PL-LAG/R

Stainless Cleaner-Protectant



HFC18.CLEAN

BALUSTRADE

SOHO™

AVAILABLE EXCLUSIVELY
FROM HOF
ACCEPT NO IMITATIONS

ITALY·USA
DESIGN COLLABORATIVE

SOHO™ | BALUSTRADE

Customize your style like never before with the latest offering from HOF. Luxurious brass and stainless steel paired with black iron makes a bold statement.



SATIN BLACK (STB)



STAINLESS STEEL (SS)

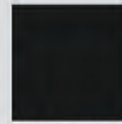

SATIN BLACK (STB)



BRASS (BR)

configuration options for your style



sleeves

BALUSTER SATIN BLACK - (Powder coated)
HFSTB16.4.1 Diameter: 20mm Rd. Length: 8" Wt. .3 lbs.
HFSTB16.4.3 Diameter: 35mm Rd. Length: 8" Wt. .75 lbs.

BALUSTER BRASS (Satin Polish - Passivated)
HF18.4.1 Diameter: 20mm Rd. Length: 8" Wt. .35 lbs.
HF18.4.3 Diameter: 35 mm Rd. Length: 8" Wt. .75 lbs.

BALUSTER STAINLESS STEEL (Satin Polish - 304 Grade)
HF17.4.1 Diameter: 20mm Rd. Length: 8" Wt. .3 lbs.
HF17.4.3 Diameter: 35mm Rd. Length: 8" Wt. .75 lbs.

newel mounting kit
flange covers

Fits 1-3/16" Round Newels
 Diameter: 4.13" Height: .7"



SATIN BLACK
HFSTB16.4.5

Also available in Ash Grey.
 See page 62.



BRASS
HF18.4.5



STAINLESS STEEL
HF17.4.5

NEWEL MOUNTING KIT

Fits 1-3/16" Round Newels
HF16.2.9



Replacement set screws
 Satin Black, Brass, Stainless Steel

balusters/newels

BALUSTER SATIN BLACK - (Powder coated)
HFSTB16.8.1 Diameter: 5/8" Rd. Tubular Length: 44" Wt. 1.35 lbs.
HFSTB16.5.11-T Diameter: 1-3/16" Rd. Tubular Length: 47" Wt. 4.8 lbs.

BALUSTER BRASS (Satin Polish - Passivated)
HF18.8.1 Diameter: 5/8" Rd. Tubular Length: 44" Wt. 1.45 lbs.
HF18.8.3 Diameter: 1-3/16" Rd. Tubular Length: 47" Wt. 5.7 lbs.

BALUSTER STAINLESS STEEL (Satin Polish - 304 Grade)
HF17.8.1 Diameter: 5/8" Rd. Tubular Length: 44" Wt. 1.2 lbs.
HF17.1.2-T Diameter: 1-3/16" Rd. Tubular Length: 47" Wt. 5.7 lbs.

Passivated to minimize tarnishing, use gloves when handling

AVAILABLE
EXCLUSIVELY
FROM HOF

ACCEPT
NO IMITATIONS

ITALY·USA
DESIGN COLLABORATIVE

FOUNDATION™

B A L U S T E R S

- TUBULAR
- NO COLLARS OR SHOES REQUIRED
- AFFORDABLE STYLE

SATIN BLACK

HFSTB16.7.5



Weight: 1.15 lbs.



ASH GREY

HFAG16.7.5



OIL RUBBED BRONZE

HFORB16.7.5



Bottom pin for quick installation!



MEGA_{COLLECTION}

Our most popular designs in a grand size



SIZE COMPARISON: Mega 3/4" vs. Standard 1/2"

MEGA_{COLLECTION}

Our most popular designs in a grand size

PERFECT FOR NEW CONSTRUCTION OR REMODEL
Create mega impact with these grand balusters

- Ideal for large or small staircases
- Perfect for replacing old wood balusters
- Traditional or modern base shoe/collar options

MEGA SQUARE



Finishes & Patinas

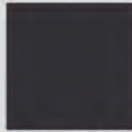

SATIN BLACK
(STB)



ASH GREY
(AG)

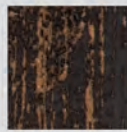

OIL RUBBED
BRONZE (ORB)



Pintop
Diameter : 5/8"
Height: 3/4"

Tubular Bar Specifications
Superior 18 gauge wall thickness
(1/20" / 1.27mm)



NEWEL

HF 16.5.8
Ends : 1-3/16" Sq.
Height: 48"
Wt. 19 lbs.
SOLID
HF 16.5.8-T
Ends : 1-3/16" Sq.
Height: 48"
Wt. 4.8 lbs.
TUBULAR

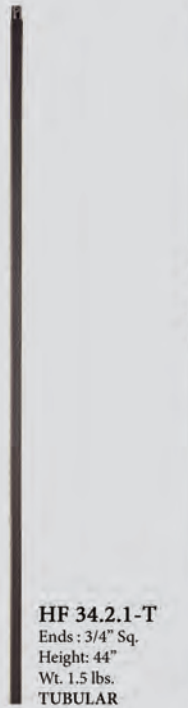

HF 34.2.1-T
Ends : 3/4" Sq.
Height: 44"
Wt. 1.5 lbs.
TUBULAR



HF 34.1.1-T
Ends : 3/4" Sq.
Height: 44"
Wt. 1.5 lbs.
TUBULAR



HF 34.1.2-T
Ends : 3/4" Sq.
Height: 44"
Wt. 1.5 lbs.
TUBULAR



HF 34.1.3-T
Ends : 3/4" Sq.
Height: 44"
Wt. 2.45 lbs.
TUBULAR

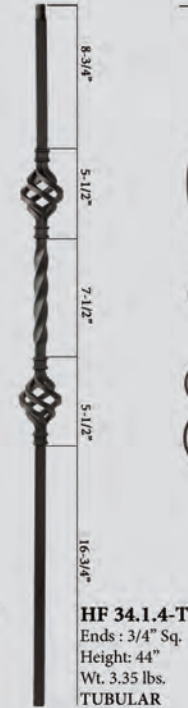

HF 34.1.4-T
Ends : 3/4" Sq.
Height: 44"
Wt. 3.35 lbs.
TUBULAR



HF 34.1.25-T
Ends : 3/4" Sq.
Height: 44"
Wt. 5.05 lbs.
TUBULAR



HF 34.1.34-T
Ends : 3/4" Sq.
Height: 44"
Wt. 1.75 lbs.
TUBULAR



HF 34.1.35-T
Ends : 3/4" Sq.
Height: 44"
Wt. 2 lbs.
TUBULAR



HF 34.6.1
Ends : 3/4" Sq.
Height: 44"
Wt. 3.25 lbs.
TUBULAR



HF 34.6.3
Ends : 3/4" Sq.
Height: 44"
Wt. 2.35 lbs.
TUBULAR



EXCLUSIVE

HF34.3.16
Level Base Collar - CAST IRON
Base : 2" Rd. - Height: 3/8" - Wt. .15 lbs.

HF34.3.19
Level Base Shoe w/Set Screw - ALUMINUM
Base : 1-7/8" Sq. - Height: 1-9/16" - Wt. .1 lbs.

HF34.3.2
Angle Base Shoe w/Set Screw - ALUMINUM
Base : 1-7/8" Sq. - Height: 2-7/8" - Wt. .15 lbs.

HF16.2.3
Newel Mounting Kit

For photos and full accessory details see pages 62-63





Oil Rubbed Bronze (shown)

WENTWORTH COLLECTION

Inspired by old world English design, Wentworth Collection is an ode to an era of simple craftsmanship and metalsmithing. Hand forged design available in our most popular finishes & patinas.



Satin Clear (shown)



Satin Clear (shown)

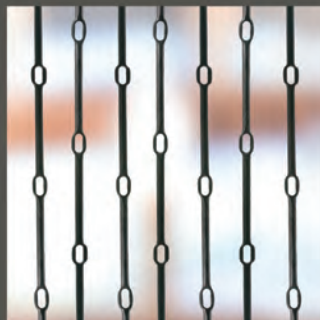

Satin Black (shown)

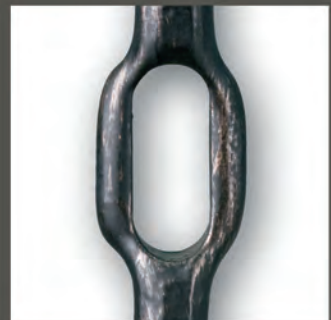

Oil Rubbed Bronze (shown)

WENTWORTH

ROUND HAND FORGED SQUARE RUSTIC HAMMERED



Finishes & Patinas



SATIN BLACK (STB)



OIL RUBBED BRONZE (ORB)

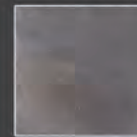

SATIN CLEAR (SC)

ACCESSORIES

Round level base shoes **HF16.3.35**
 Round angled base shoes **HF16.3.36**

Square level base shoes **HF16.3.38**
 Square angled base shoes **HF16.3.39**





Round newel mounting kit **HF16.3.33**
 Square newel mounting kit **HF16.3.31**

Photos: J.
 Photos: N.

Photos: C.
 Photos: G.

Photos: U.
 Photos: T.

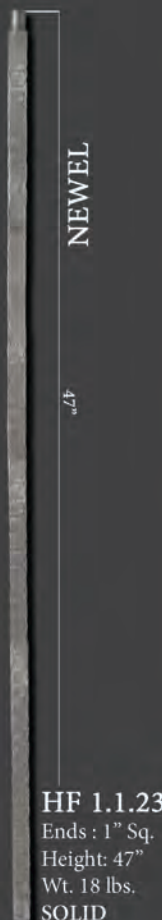
For photos and full accessory details see pages 62-63

 <p>NEWEL</p> <p>47"</p>	 <p>44"</p>	 <p>9-1/2"</p> <p>2"</p> <p>7"</p> <p>2"</p> <p>7"</p> <p>2"</p> <p>14-1/2"</p>	 <p>NEWEL</p> <p>47"</p>	 <p>44"</p>	 <p>9-1/2"</p> <p>1-1/2"</p> <p>7-3/4"</p> <p>1-1/2"</p> <p>7-3/4"</p> <p>1-1/2"</p> <p>14-1/2"</p>
<p>HF 1.1.22 Ends : 1" Rd. Height: 47" Wt. 18 lbs. SOLID</p>	<p>HF 3.1.1 Ends : 5/8" Rd. Height: 44" Wt. 3.6 lbs. SOLID</p>	<p>HF 3.1.2 Ends : 5/8" Rd. Height: 44" Wt. 3.58 lbs. SOLID</p>	<p>HF 1.1.23 Ends : 1" Sq. Height: 47" Wt. 18 lbs. SOLID</p>	<p>HF 3.2.1 Ends : 5/8" Sq. Height: 44" Wt. 4.28 lbs. SOLID</p>	<p>HF 3.2.2 Ends : 5/8" Sq. Height: 44" Wt. 5.2 lbs. SOLID</p>

Hand forged product, variance in specifications may occur.



Satin Black (shown)



Oil Rubbed Bronze (shown)

AALTO



Ash Grey (shown)

Ash Grey (shown)

Our Aalto collection is a compliment to the modern design aesthetic. Adorn any space with the clean lines and open detail of these modern balusters and panels.



Satin Black (shown)



Satin Black (shown)



Satin Black (shown)



Ash Grey (shown)



Ash Grey (shown)

AALTO

SQUARE



Finishes & Patinas

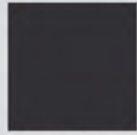

SATIN BLACK
(STB)

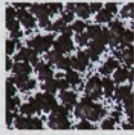

SILVER VEIN
(SP)



ASH GREY
(AG)



DORADO GOLD
(GD)

	NEWELS	HF16.5.8	HF16.5.8-T	BALUSTERS	HF16.2.1	HF16.2.1-T	HF16.2.1-50	HF16.1.30	HF16.1.30-T	HF16.1.31	HF16.1.31-T	HF16.1.32	HF16.1.32-T	HF16.6.1	HF16.6.2	HF16.6.3	HF16.6.4	HF16.6.5	HF16.6.7	HF16.6.8	HF16.6.9	HF9.4.11	HF9.4.22	HF9.4.33	HF9.4.44
STB		•			•	•	•	•		•		•		•	•	•	•	•	•	•	•	•	•	•	•
SP		•			•	•				•		•													
AG			•			•			•		•		•	•	•	•	•	•	•	•	•	•	•	•	•
GD		•			•									•		•			•						

ACCESSORIES

Level base shoes

Level base collars

Angled base shoes

Adjustable level base shoes

Adjustable angle base shoes

Level base collars(modern)

Newel mounting kit

HF16.3.1, HF16.3.19

HF16.3.4, HF16.3.5,

HF16.3.2, HF16.3.30

HF16.3.44, HF16.3.46

HF16.3.45, HF16.3.47

HF16.3.9

HF16.2.3

Photos: A. A.

Photos: D. H.

Photos: E. G.

Photos: R.

Photos: S.

Photos: P. **NEW**

Photos: T.

For photos and full accessory details see pages 62-63



Satin Black (shown)



HF 16.5.8
Ends: 1-3/16" Sq.
Height: 48"
Wt. 19 lbs.
SOLID
HF 16.5.8-T
Ends: 1-3/16" Sq.
Height: 48"
Wt. 4.8 lbs.
TUBULAR

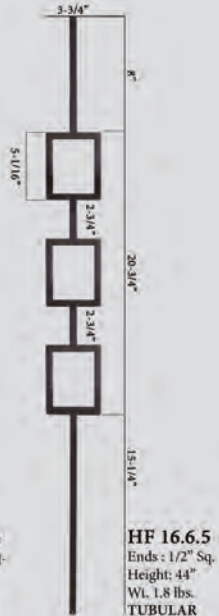
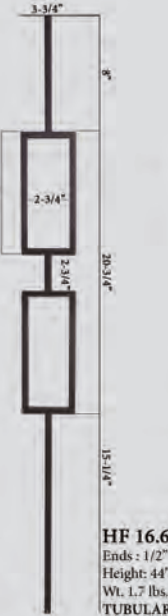
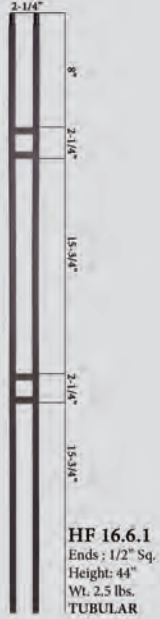
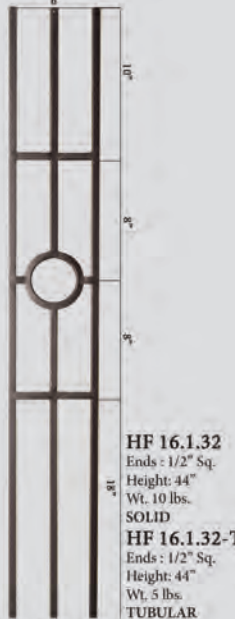
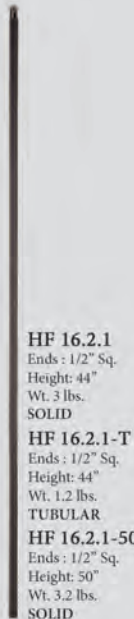

fits all angles up to 40 degrees





Satin Clear (shown)

The craftsmanship in these hand-forged balusters exude character and beauty nearly impossible to duplicate. Our Tuscan series is available in both round forged and square hammered profiles. Bring the rustic charm of old world Italy into your home with this unique series.

Oil Rubbed Bronze (shown)

TUSCAN

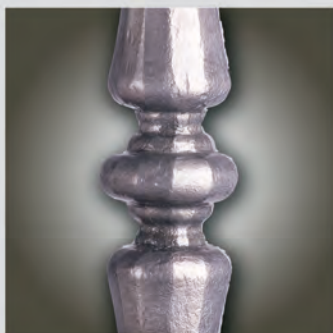

Satin Clear (shown)

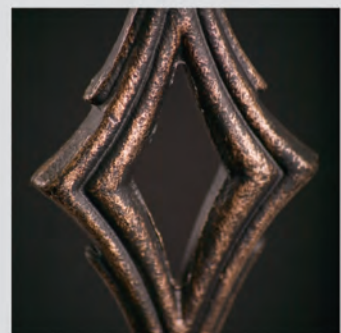

Oil Rubbed Bronze (shown)

TUSCAN

ROUND HAND FORGED



Finishes & Patinas

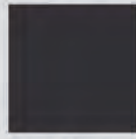

SATIN BLACK (STB)



OIL RUBBED BRONZE (ORB)



SATIN CLEAR (SC)

	NEWELS	HF1.1.22	HF1.1.8	HF1.1.9	HF1.1.16	HF1.1.20	HF1.1.21	BALUSTERS	HF2.9.21	HF2.1.5	HF2.1.6	HF2.1.7	HF2.1.9	HF2.1.8	HF2.1.11	HF2.6.8	HF2.6.9	HF2.6.7	HF2.10.2	HF2.10.4	HF2.10.3	HF2.11.40	HF2.11.41
STB		•	•	•	•	•	•		•	•	•	•	•	•	•	•	•	•	•	•	•	•	•
ORB		•	•	•	•	•	•		•	•	•	•	•	•	•	•	•	•	•	•	•	•	•
SC		•			•		•		•							•	•	•	•	•	•		

ACCESSORIES

- Level base shoes **HF16.3.26**
- Level base collars **HF16.3.40, HF16.3.43**
- Angled base shoes **HF16.3.27**
- Adjustable level base shoes **HF16.3.44, HF16.3.46**
- Adjustable angle base shoes **HF16.3.45, HF16.3.47**
- Level base collars(modern) **HF16.3.10**

- Photos: J.
- Photos: K. O.
- Photos: N.
- Photos: R.
- Photos: S.
- Photos: Q. **NEW**

For photos and full accessory details see pages 62-63



NEWEL
47-1/4"

NEWEL
17-1/8"
5-3/8"
24-3/4"

NEWEL
18-1/8"
3"
26-1/8"

NEWEL
17-1/8"
5"
25-1/8"

NEWEL
14-13/16"
8-14/16"
24-3/16"

NEWEL
14-3/8"
10-5/8"
2-3/4"
22-1/4"

NEWEL
17-1/2"
4-1/2"
22"

NEWEL
12-1/2"
14-1/2"
17"

NEWEL
9"
4-1/2"
11"
4-1/2"
15"

HF 1.1.22
Ends : 1" Rd.
Height: 47-1/4"
Wt. 18 lbs.

HF 1.1.8
Ends : 1" Rd.
Height: 47-1/4"
Wt. 18 lbs.

HF 1.1.9
Ends : 1" Rd.
Height: 47-1/4"
Wt. 18 lbs.

HF 1.1.16
Ends : 1" Rd.
Height: 47-1/4"
Wt. 18 lbs.

HF 1.1.20
Ends : 1" Rd.
Height: 47-1/4"
Wt. 18 lbs.

HF 1.1.21
Ends : 1" Rd.
Tapered
Height: 47-1/4"
Wt. 18 lbs.

HF 2.1.5
Ends : 9/16" Rd.
Height: 44"
Wt. 2.5 lbs.

HF 2.1.6
Ends : 9/16" Rd.
Height: 44"
Wt. 4.2 lbs.

HF 2.1.7
Ends : 9/16" Rd.
Height: 44"
Wt. 3 lbs.



HF 2.1.9
 Ends : 9/16" Rd.
 Height: 44"
 Wt. 2.4 lbs.



HF 2.1.8
 Ends : 9/16" Rd.
 Height: 44"
 Wt. 4.2 lbs.



HF 2.1.11
 Ends : 9/16" Rd.
 Height: 44"
 Wt. 3 lbs.



HF 2.6.8
 Ends : 9/16" Rd.
 Tapered
 Height: 44"
 Wt. 3.2 lbs.



HF 2.6.9
 Ends : 9/16" Rd.
 Height: 44"
 Wt. 4.2 lbs.



HF 2.6.7
 Ends : 9/16" Rd.
 Tapered
 Height: 44"
 Wt. 3.8 lbs.



HF 2.9.21
 Ends : 9/16" Rd.
 Height: 44"
 Wt. 2.4 lbs.



HF 2.10.2
 Ends : 9/16" Rd.
 Height: 44"
 Wt. 3.2 lbs.



HF 2.10.4
 Ends : 9/16" Rd.
 Height: 44"
 Wt. 4.2 lbs.



HF 2.10.3
 Ends : 9/16" Rd.
 Height: 44"
 Wt. 3.6 lbs.



HF 2.11.40
 Ends : 9/16" Rd.
 Height: 44"
 Wt. 4 lbs.



HF 2.11.41
 Ends : 9/16" Rd.
 Height: 44"
 Wt. 5.2 lbs.

TUSCAN

SQUARE HAND HAMMERED



Finishes & Patinas



SATIN BLACK (STB)



OIL RUBBED BRONZE (ORB)



SATIN CLEAR (SC)

	NEWELS	HF1.1.10	HF1.1.11	HF1.1.14	HF1.1.14-T	HF1.1.15	HF1.1.15-T	BALUSTERS	HF2.9.12	HF2.9.11	HF2.9.13	HF2.9.3	HF2.9.4	HF2.9.8	HF2.9.5	HF2.9.6	HF2.1.2	HF2.1.1	HF2.9.20	HF2.9.20-T	HF2.9.28	HF2.9.28-T	HF2.9.27	HF2.9.26	HF2.9.26-T	HF2.9.29	HF2.9.36	HF2.9.37
STB	•	•	•	•	•	•	•		•	•	•	•	•	•	•	•	•	•	•	•	•	•	•	•	•	•	•	•
ORB		•	•	•	•	•	•		•	•	•	•	•	•	•	•	•	•	•	•	•	•	•	•	•	•	•	•
SC			•	•		•			•	•	•			•						•		•		•				

ACCESSORIES

- Level base shoes
- Level base collars
- Angled base shoes
- Adjustable level base shoes
- Adjustable angle base shoes
- Level base collars(modern)
- Newel mounting kit

- HF16.3.25
- HF16.3.41, HF16.3.42
- HF16.3.28
- HF16.3.44, HF16.3.46
- HF16.3.45, HF16.3.47
- HF16.3.11
- HF16.3.31

- Photos: C.
- Photos: D. H.
- Photos: G.
- Photos: R.
- Photos: S.
- Photos: P. **NEW**
- Photos: T.

For photos and full accessory details see pages 62-63



NEWEL

15-1/2"

8-1/2"

23-1/4"

HF 1.1.10
Ends : 1" Sq.
Tapered
Height: 47-1/4"
Wt. 18 lbs.

NEWEL

16-1/4"

7"

24"

HF 1.1.11
Ends : 1" Sq.
Tapered
Height: 47-1/4"
Wt. 18 lbs.

NEWEL

47-1/4"

HF 1.1.14-T
Ends : 1" Sq.
Height: 47-1/4"
Wt. 2.30 lbs.
TUBULAR

NEWEL

17-1/8"

5"

25-1/8"

HF 1.1.15
Ends : 1" Sq.
Height: 47-1/4"
Wt. 18 lbs.
SOLID

HF 1.1.15-T
Ends : 1" Sq.
Height: 47-1/4"
Wt. 5.30 lbs.
TUBULAR

17-1/2"

4-1/2"

22"

HF 2.9.12
Ends : 9/16" Sq.
Tapered
Height: 44"
Wt. 3.8 lbs.

5"

12-1/2"

14-1/2"

17"

HF 2.9.11
Ends : 9/16" Sq.
Height: 44"
Wt. 5 lbs.

10"

4-1/2"

10-1/2"

4-1/2"

14-1/2"

HF 2.9.13
Ends : 9/16" Sq.
Tapered
Height: 44"
Wt. 5.5 lbs.

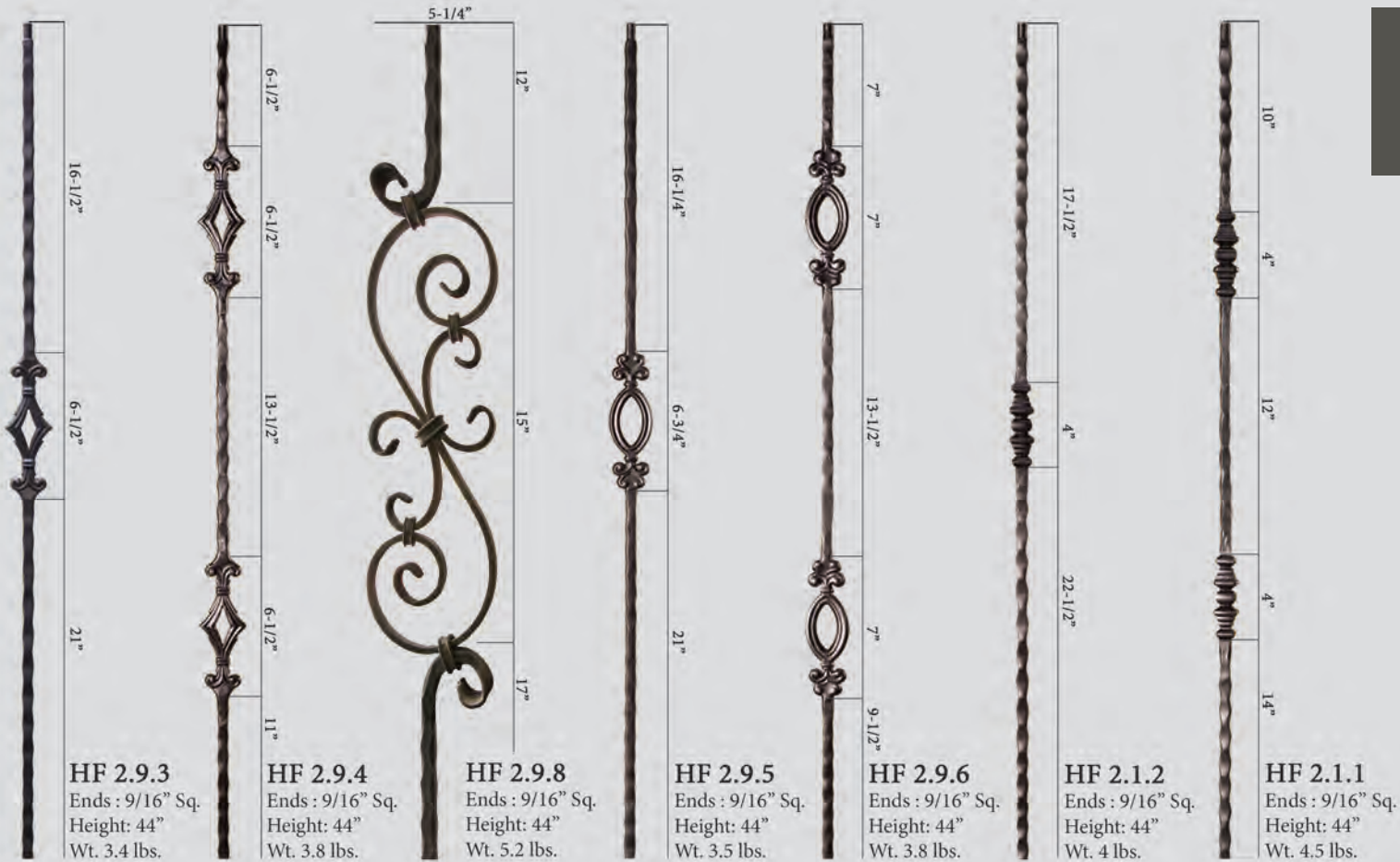

HF 2.9.3
Ends : 9/16" Sq.
Height: 44"
Wt. 3.4 lbs.

HF 2.9.4
Ends : 9/16" Sq.
Height: 44"
Wt. 3.8 lbs.

HF 2.9.8
Ends : 9/16" Sq.
Height: 44"
Wt. 5.2 lbs.

HF 2.9.5
Ends : 9/16" Sq.
Height: 44"
Wt. 3.5 lbs.

HF 2.9.6
Ends : 9/16" Sq.
Height: 44"
Wt. 3.8 lbs.

HF 2.1.2
Ends : 9/16" Sq.
Height: 44"
Wt. 4 lbs.

HF 2.1.1
Ends : 9/16" Sq.
Height: 44"
Wt. 4.5 lbs.

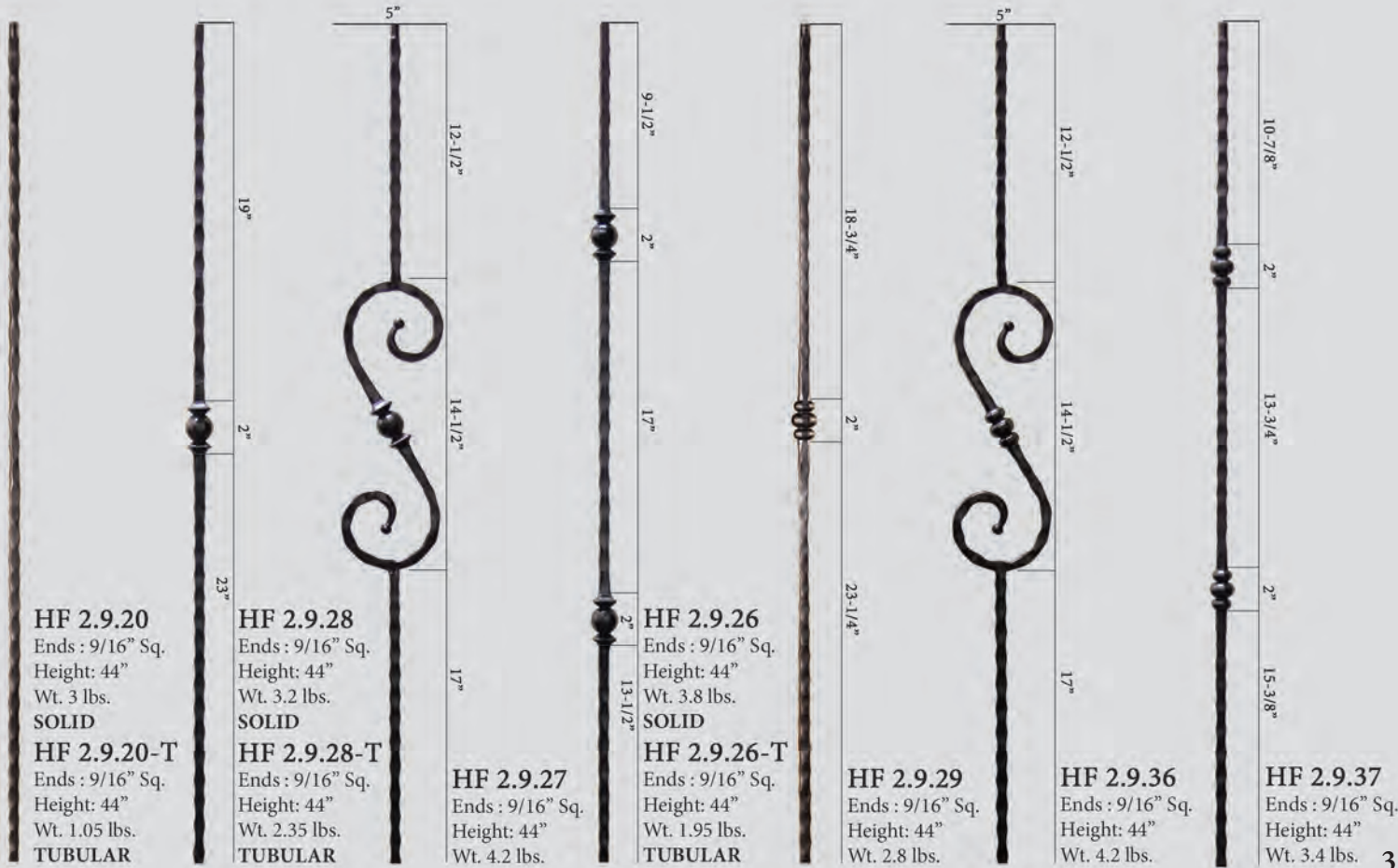

HF 2.9.20
Ends : 9/16" Sq.
Height: 44"
Wt. 3 lbs.
SOLID

HF 2.9.20-T
Ends : 9/16" Sq.
Height: 44"
Wt. 1.05 lbs.
TUBULAR

HF 2.9.28
Ends : 9/16" Sq.
Height: 44"
Wt. 3.2 lbs.
SOLID

HF 2.9.28-T
Ends : 9/16" Sq.
Height: 44"
Wt. 2.35 lbs.
TUBULAR

HF 2.9.27
Ends : 9/16" Sq.
Height: 44"
Wt. 4.2 lbs.

HF 2.9.26
Ends : 9/16" Sq.
Height: 44"
Wt. 3.8 lbs.
SOLID

HF 2.9.26-T
Ends : 9/16" Sq.
Height: 44"
Wt. 1.95 lbs.
TUBULAR

HF 2.9.29
Ends : 9/16" Sq.
Height: 44"
Wt. 2.8 lbs.

HF 2.9.36
Ends : 9/16" Sq.
Height: 44"
Wt. 4.2 lbs.

HF 2.9.37
Ends : 9/16" Sq.
Height: 44"
Wt. 3.4 lbs.

MONTE CARLO

Oil Rubbed Bronze (shown)

Drawing inspiration from the great Roman columns, the Monte Carlo series stands alone in style and elegance. The robust designs compliment the prominence of even the grandest estates. The intricately cast components are highlighted by the Oil Rubbed Bronze patina.

Oil Rubbed Bronze (shown)

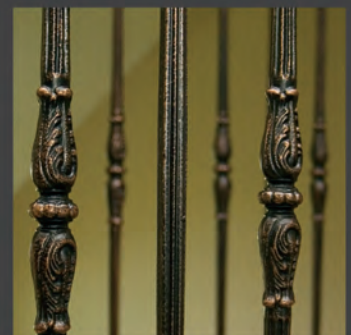

MONTE CARLO

ROUND



Finishes & Patinas



SATIN BLACK
(STB)

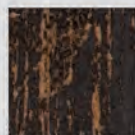

OIL RUBBED
BRONZE
(ORB)



NEWEL

16-1/8"

5-1/8"

22-3/4"

HF 18.1.1-T
Ends : 1-3/16" Rd.
Height: 48"
Wt. 18.55 lbs.
TUBULAR

*Middle section is hollow cast iron,
ends are hollow cast steel



6-5/16"

1-1/8"

6-7/16"

19-5/8"

1-1/8"

14-5/16"

HF 18.2.1-T
Ends : 5/8" Rd.
Height: 44"
Wt. 1.75 lbs.
TUBULAR

*Middle section is hollow cast aluminum, ends are hollow cast steel



6-5/16"

1-1/8"

19-5/8"

1-1/8"

14-5/16"

HF 18.2.2-T
Ends : 5/8" Rd.
Height: 44"
Wt. 1.50 lbs.
TUBULAR

ACCESSORIES

- Level base shoes
- Angled base shoes
- Level base collars(modern)
- Newel mounting kit

- HF16.3.50**
- HF16.3.51**
- HF16.3.12**
- HF16.3.14**

- Photos: I.
- Photos: M.
- Photos: Q. **NEW**
- Photos: U.

For photos and full accesory details see pages 62-63



DESIGNER



Oil Rubbed Bronze (shown)

The designer series offers an upgraded look at an affordable price for homebuilders and homeowners alike. These hollow balusters are offered in square or round and compliment a wide range of architectural styles.

Oil Rubbed Bronze (shown)



Oil Rubbed Bronze (shown)

DESIGNER TUBULAR

ROUND

SQUARE



Finishes & Patinas

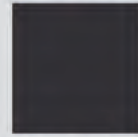

SATIN BLACK (STB)



OIL RUBBED BRONZE (ORB)



HF 16.8.1
Ends : 5/8" Rd.
Height: 44"
Wt. 2 lbs.
TUBULAR



HF 16.8.2
Ends : 5/8" Rd.
Height: 44"
Wt. 2 lbs.
TUBULAR



HF 16.8.3
Ends : 5/8" Rd.
Height: 44"
Wt. 2 lbs.
TUBULAR



HF 16.8.4
Ends : 5/8" Rd.
Height: 44"
Wt. 3 lbs.
TUBULAR



HF 16.8.5
Ends : 5/8" Rd.
Height: 44"
Wt. 3 lbs.
TUBULAR



HF 16.8.6
Ends : 5/8" Sq.
Height: 44"
Wt. 2 lbs.
TUBULAR



HF 16.8.10
Ends : 5/8" Sq.
Height: 44"
Wt. 2 lbs.
TUBULAR



HF 16.8.11
Ends : 5/8" Sq.
Height: 44"
Wt. 2 lbs.
TUBULAR



HF 16.8.8
Ends : 5/8" Sq.
Height: 44"
Wt. 3 lbs.
TUBULAR



HF 16.8.9
Ends : 5/8" Sq.
Height: 44"
Wt. 4 lbs.
TUBULAR

ACCESSORIES

- Level base shoes
- Angled base shoes
- Level base collars(modern)
- Level base collars(modern)

HF16.3.35, HF16.3.38
HF16.3.36, HF16.3.39
HF16.3.15
HF16.3.12

Photos: J. C.
Photos: N. G.
Photos: P. **NEW**
Photos: Q. **NEW**

For photos and full accessory details see pages 62-63



STAINLESS STEEL



Stainless steel is a mainstay in the modern and contemporary home decor market. The simple, honest lines of this profile is the perfect compliment to your urban dwelling. Now, offered in a more affordable tubular style for the budget savy buyer.



STAINLESS STEEL



ACCESSORIES

Level base collar
Newel mounting kit

HF17.11.22
HF17.2.3

Photos: L.
Photos: V.

For photos and full accessory details see pages 62-63





SANTA FE

Satin Black (shown)

Our Santa Fe collection of edge hammered balusters are reminiscent of the old world Spanish architecture found in rustic Mexican villas. The bold, distinct hammering is the key to turning your home into an impressive estate.

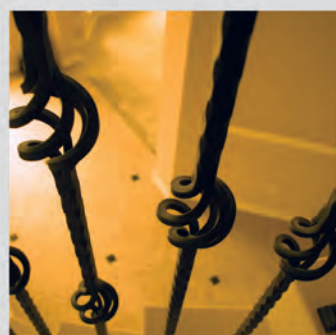

Satin Black (shown)

SANTA FE

SQUARE EDGE HAMMERED



Finishes & Patinas

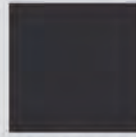

SATIN BLACK
(STB)



HF 16.3.8
Ends : 9/16" Sq.
Height: 44"
Wt. 3.7 lbs.



HF 16.1.26
Ends : 9/16" Sq.
Height: 44"
Wt. 4 lbs.



HF 16.1.27
Ends : 9/16" Sq.
Height: 44"
Wt. 4.5 lbs.



HF 16.1.15
Ends : 9/16" Sq.
Height: 44"
Wt. 3 lbs.



HF 16.1.22
Ends : 9/16" Sq.
Height: 44"
Wt. 3.6 lbs.

ACCESSORIES

- Level base shoes
- Angled base shoes
- Adjustable level base shoes
- Adjustable angle base shoes
- Level base collars(modern)

- HF16.3.3**
- HF16.3.17**
- HF16.3.44, HF16.3.46**
- HF16.3.45, HF16.3.47**
- HF16.3.11**

- Photos: A.
- Photos: E.
- Photos: R.
- Photos: S.
- Photos: P. **NEW**

For photos and full accessory details see pages 62-63





GOTHIC

Oil Rubbed Copper (shown)

The inspiration for our Gothic series was the timeless ironwork featured in many European castles and estates. These prominent designs will compliment old world hardware and fixtures found throughout many homes today.

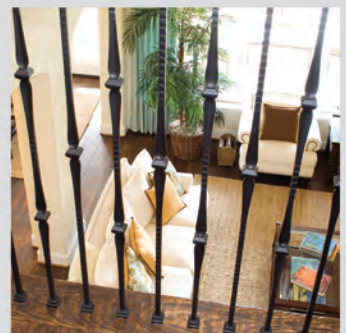

Oil Rubbed Copper (shown)

GOTHIC

SQUARE FACE HAMMERED



Finishes & Patinas



SATIN BLACK
(STB)



OIL RUBBED
BRONZE
(ORB)



OIL RUBBED
COPPER
(ORC)



NEWEL

HF 16.5.6
Ends : 1-3/16" Sq.
Height: 48"
Wt. 22 lbs.



HF 16.1.7
Ends : 9/16" Sq.
Height: 44"
Wt. 4 lbs.



HF 16.5.2
Ends : 9/16" Sq.
Height: 44"
Wt. 3.5 lbs.



HF 16.1.8
Ends : 9/16" Sq.
Height: 44"
Wt. 3.8 lbs.



HF 16.1.9
Ends : 9/16" Sq.
Height: 44"
Wt. 4.5 lbs.

ACCESSORIES

- Level base shoes
- Level base collars
- Angled base shoes
- Adjustable level base shoes
- Adjustable angle base shoes
- Level base collars(modern)
- Newel mounting kit

- HF16.3.3, HF16.3.20, HF16.3.25**
- HF16.3.41, HF16.3.42**
- HF16.3.17, HF16.3.28**
- HF16.3.44, HF16.3.46**
- HF16.3.45, HF16.3.47**
- HF16.3.11**
- HF16.2.3**

- Photos: A. A. C.
- Photos: D. H.
- Photos: E. G.
- Photos: R.
- Photos: S.
- Photos: P. **NEW**
- Photos: T.

For photos and full accessory details see pages 62-63





Satin Black (shown)

The style of this collection provides a sleek appearance that strikes a perfect balance between traditional and contemporary.

Ash Grey (shown)

ROUND



Oil Rubbed Bronze, Satin Black (shown)



Oil Rubbed Bronze (shown)



Satin Black (shown)



Ash Grey/Satin Black (shown)

ROUND

ROUND SMOOTH



Finishes & Patinas



SATIN BLACK (STB)



OIL RUBBED BRONZE (ORB)



ASH GREY (AG)

	NEWELS	HF16.5.10	HF16.5.11	HF16.5.11-T	HF1.1.19	BALUSTERS	HF16.2.2	HF16.1.17	HF16.1.18	HF16.1.19	HF16.1.20	HF16.1.25-R	HF2.11.3	HF2.11.3-T	HF2.11.4	HF2.11.4-T	HF2.11.16	HF2.11.16-T	HF2.8.18	HF16.8.1	HF16.8.12	HF16.8.13	HF16.8.14	
STB		•	•		•		•	•	•	•	•	•	•	•	•	•	•	•	•	•	•	•	•	
ORB			•		•							•	•	•	•	•	•	•	•					
AG				•										•		•				•	•	•		



NEWEL

HF 16.5.10
Ends : 1-3/16" Rd.
Height: 48"
Wt. 19 lbs.



NEWEL

HF 16.5.11
Ends : 1-3/16" Rd.
Height: 48"
Wt. 19 lbs.
SOLID
HF 16.5.11-T
Ends : 1-3/16" Rd.
Height: 48"
Wt. 5.7 lbs.
TUBULAR



HF 16.2.2
Ends : 9/16" Rd.
Height: 44"
Wt. 2.7 lbs.



HF 16.1.17
Ends : 9/16" Rd.
Height: 44"
Wt. 2.7 lbs.



HF 16.1.18
Ends : 9/16" Rd.
Height: 44"
Wt. 3 lbs.



HF 16.1.19
Ends : 9/16" Rd.
Height: 44"
Wt. 4 lbs.



HF 16.1.20
Ends : 9/16" Rd.
Height: 44"
Wt. 5 lbs.



HF 1.1.19
Ends : 1" Rd.
Height: 48"
Wt. 19 lbs.



HF 16.1.25-R
Ends : 9/16" Rd.
Height: 44"
Wt. 5.2 lbs.



HF 2.8.18
Ends : 9/16" Rd.
Height: 44"
Wt. 2.7 lbs.
SOLID
HF 16.8.1
Ends : 5/8" Rd.
Height: 44"
Wt. 2 lbs.
TUBULAR



HF 2.11.3
Ends : 9/16" Rd.
Height: 44"
Wt. 3 lbs.
SOLID
HF 2.11.3-T
Ends : 5/8" Rd.
Height: 44"
Wt. 2 lbs.
TUBULAR



HF 2.11.4
Ends : 9/16" Rd.
Height: 44"
Wt. 3 lbs.
SOLID
HF 2.11.4-T
Ends : 5/8" Rd.
Height: 44"
Wt. 2 lbs.
TUBULAR



HF 2.11.16
Ends : 9/16" Rd.
Height: 44"
Wt. 3.5 lbs.
SOLID
HF 2.11.16-T
Ends : 5/8" Rd.
Height: 44"
Wt. 2.5 lbs.
TUBULAR



HF 16.8.12
Ends : 5/8" Rd.
Height: 44"
Wt. 1.3 lbs.
TUBULAR



HF 16.8.13
Ends : 5/8" Rd.
Height: 44"
Wt. 1.3 lbs.
TUBULAR

ACCESSORIES

- Level base shoes
- Level base collars
- Angled base shoes
- Adjustable level base shoes
- Adjustable angle base shoes
- Level base shoe, fits 5/8"
- Angled base shoe, fits 5/8"
- Level base collars(modern)
- Newel mounting kit

- HF 16.3.13, HF 16.3.26**
- HF 16.3.40, HF 16.3.43**
- HF 16.3.16, HF 16.3.27**
- HF 16.3.44, HF 16.3.46**
- HF 16.3.45, HF 16.3.47**
- HF 16.3.35**
- HF 16.3.36**
- HF 16.3.10, HF 16.3.12**
- HF 16.3.14, HF 16.3.33, HF 16.2.9**

- Photos: L. J.
- Photos: K. O.
- Photos: M. N.
- Photos: R.
- Photos: S.
- Photos: J.
- Photos: N.
- Photos: Q. **NEW**
- Photos: U.

For photos and full accessory details see pages 62-63 



Ash Grey (shown)

The endless baluster combinations in this series offers a match for your individual taste and style. These balusters compliment our Scroll, Twist and Ribbon series.

Silver Vein (shown)

VERSATILE



Satin Black (shown)



Oil Rubbed Bronze (shown)



VERSATILE SQUARE



Finishes & Patinas



	NEWELS	HF16.5.8	HF16.5.8-T	HF16.5.9	HF16.5.9-T	BALUSTERS	HF16.2.1	HF16.2.1-T	HF16.2.1-50	HF16.1.34	HF16.1.34-T	HF16.1.35	HF16.1.35-T	HF16.1.45	HF16.1.45-T	HF2.10.1	HF2.2.3	HF16.1.25	HF16.1.25-T	HF16.1.25-S	
STB		•		•			•	•	•	•	•	•	•	•	•	•	•	•	•	•	•
AG			•		•			•			•		•							•	
SP		•		•			•	•													
CV							•	•			•		•							•	•
ORB		•		•			•	•		•	•	•	•			•	•	•	•	•	•
ORC		•		•			•	•		•	•	•	•			•	•	•	•	•	•

NEWEL

HF 16.5.8
Ends : 1-3/16" Sq.
Height: 48"
Wt. 19 lbs.
SOLID

HF 16.5.8-T
Ends : 1-3/16" Sq.
Height: 48"
Wt. 4.8 lbs.
TUBULAR

HF 16.5.9
Ends : 1-3/16" Sq.
Height: 48"
Wt. 20 lbs.
SOLID

HF 16.5.9-T
Ends : 1-3/16" Sq.
Height: 48"
Wt. 9.7 lbs.
TUBULAR

HF 16.2.1
Ends : 1/2" Sq.
Height: 44"
Wt. 3 lbs.
SOLID

HF 16.2.1-T
Ends : 1/2" Sq.
Height: 44"
Wt. 1.2 lbs.
TUBULAR

HF 16.2.1-50
Ends : 1/2" Sq.
Height: 50"
Wt. 3.2 lbs.
SOLID

HF 16.1.34
Ends : 1/2" Sq.
Height: 44"
Wt. 4 lbs.
SOLID

HF 16.1.34-T
Ends : 1/2" Sq.
Height: 44"
Wt. 1.35 lbs.
TUBULAR

HF 16.1.35
Ends : 1/2" Sq.
Height: 44"
Wt. 3.5 lbs.
SOLID

HF 16.1.35-T
Ends : 1/2" Sq.
Height: 44"
Wt. 1.5 lbs.
TUBULAR

HF 16.1.45
Ends : 1/2" Sq.
Height: 44"
Wt. 4 lbs.
SOLID

HF 16.1.45-T
Ends : 1/2" Sq.
Height: 44"
Wt. 1.55 lbs.
TUBULAR



HF 2.10.1
 Ends : 1/2" Sq.
 Height: 44"
 Wt. 4.2 lbs.



HF 2.2.3
 Ends : 1/2" Sq.
 Height: 44"
 Wt. 3 lbs.



HF 16.1.25
 Ends : 1/2" Sq.
 Height: 44"
 Wt. 5.2 lbs.
SOLID

HF 16.1.25-T
 Ends : 1/2" Sq.
 Height: 44"
 Wt. 3.85 lbs.
TUBULAR



HF 16.1.25-S
 Ends : 1/2" Sq.
 Height: 44"
 Wt. 5.2 lbs.

ACCESSORIES

- Level base shoes
- Level base collars
- Angled base shoes
- Adjustable level base shoes
- Adjustable angle base shoes
- Level base collars(modern)
- Versatile style knuckle
- Newel mounting kit

- HF16.3.1, HF16.3.19, HF16.3.29**
- HF16.3.4, HF16.3.5,**
- HF16.3.2, HF16.3.30**
- HF16.3.44, HF16.3.46**
- HF16.3.45, HF16.3.47**
- HF16.3.9**
- HF16.5.1**
- HF16.2.3**

- Photos: A. A. C.
- Photos: D. H.
- Photos: E. G.
- Photos: R.
- Photos: S.
- Photos: P. **NEW**
- Photos: F.
- Photos: T.

For photos and full accessory details see pages 62-63





Satin Black (shown)

This ribbon style twist in this series pairs nicely with balusters from the Versatile series. The ribbon is accented nicely by the Oil Rubbed Bronze patina as well as the Copper Vein finish.

Copper Vein (shown)

RIBBON



RIBBON SQUARE



Finishes & Patinas

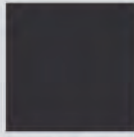

SATIN BLACK
(STB)



OIL RUBBED
BRONZE
(ORB)



OIL RUBBED
COPPER
(ORC)



NEWEL

HF 16.5.7
Ends : 1-3/16" Sq.
Height: 48"
Wt. 19 lbs.



HF 16.1.5
Ends : 1/2" Sq.
Height: 44"
Wt. 3.2 lbs.



HF 16.1.6
Ends : 1/2" Sq.
Height: 44"
Wt. 3 lbs.



HF 16.3.6
Ends : 1/2" Sq.
Height: 44"
Wt. 3.2 lbs.

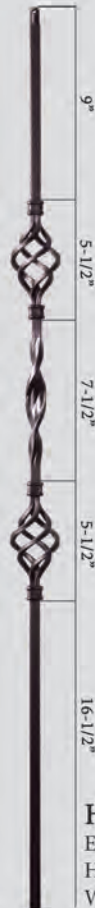

HF 16.3.7
Ends : 1/2" Sq.
Height: 44"
Wt. 4 lbs.



HF 16.1.10
 Ends : 1/2" Sq.
 Height: 44"
 Wt. 3.6 lbs.



HF 16.1.11
 Ends : 1/2" Sq.
 Height: 44"
 Wt. 4.1 lbs.

ACCESSORIES

- Level base shoes
- Level base collars
- Angled base shoes
- Adjustable level base shoes
- Adjustable angle base shoes
- Level base collars(modern)
- Versatile style knuckle
- Newel mounting kit

- HF16.3.1, HF16.3.19, HF16.3.29**
- HF16.3.4, HF16.3.5,**
- HF16.3.2, HF16.3.30**
- HF16.3.44, HF16.3.46**
- HF16.3.45, HF16.3.47**
- HF16.3.9**
- HF16.5.1**
- HF16.2.3**

- Photos: A. A. C.
- Photos: D. H.
- Photos: E. G.
- Photos: R.
- Photos: S.
- Photos: P. **NEW**
- Photos: F.
- Photos: T.

For photos and full accessory details see pages 62-63





TWIST

Satin Black (shown)

This popular twist and basket design is a mainstay featured in many new homes. These balusters and newels are offered in an extensive range of finishes and patinas. They combine seamlessly with profiles from the Versatile series.

Oil Rubbed Copper (shown)



Satin Black (shown)

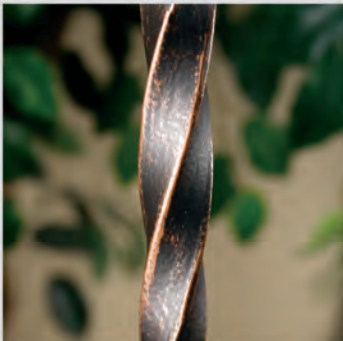

Oil Rubbed Bronze (shown)



Ash Grey (shown)

TWIST SQUARE



Finishes & Patinas



	NEWELS	HF16.5.4	HF16.5.4-T	HF16.5.5	HF16.5.5-T	BALUSTERS	HF16.1.1	HF16.1.1-T	HF16.1.2	HF16.1.2-T	HF16.1.3	HF16.1.3-T	HF16.1.4	HF16.1.4-T	HF16.1.21	HF16.1.21-T	HF16.1.16	HF16.1.41	
STB		•		•			•	•	•	•	•	•	•	•	•	•	•	•	•
AG			•		•			•		•		•		•		•			
SP		•		•			•	•	•	•	•	•	•	•	•	•	•		
CV		•		•			•	•	•	•	•	•	•	•	•	•	•		
ORB		•		•			•	•	•	•	•	•	•	•	•	•	•		
ORC		•		•			•	•	•	•	•	•	•	•	•	•	•		

NEWEL

13-1/4"

11-1/2"

23-1/4"

HF 16.5.4
Ends : 1-3/16" Sq.
Height: 48"
Wt. 18 lbs.
SOLID

HF 16.5.4-T
Ends : 1-3/16" Sq.
Height: 48"
Wt. 5.5 lbs.
TUBULAR

NEWEL

5-1/2"

7-1/4"

3-1/2"

6-1/2"

3-1/2"

7-1/4"

14-1/2"

HF 16.5.5
Ends : 1-3/16" Sq.
Height: 48"
Wt. 20 lbs.
SOLID

HF 16.5.5-T
Ends : 1-3/16" Sq.
Height: 48"
Wt. 7.6 lbs.
TUBULAR

15"

6"

23"

HF 16.1.1
Ends : 1/2" Sq.
Height: 44"
Wt. 3 lbs.
SOLID

HF 16.1.1-T
Ends : 1/2" Sq.
Height: 44"
Wt. 1.2 lbs.
TUBULAR

9"

6"

6"

6"

17"

HF 16.1.2
Ends : 1/2" Sq.
Height: 44"
Wt. 3 lbs.
SOLID

HF 16.1.2-T
Ends : 1/2" Sq.
Height: 44"
Wt. 1.15 lbs.
TUBULAR

6"

6"

3"

5-1/2"

3-1/2"

6"

14"

HF 16.1.3
Ends : 1/2" Sq.
Height: 44"
Wt. 4 lbs.
SOLID

HF 16.1.3-T
Ends : 1/2" Sq.
Height: 44"
Wt. 1.55 lbs.
TUBULAR

8"

5-1/2"

8"

5-1/2"

17"

HF 16.1.4
Ends : 1/2" Sq.
Height: 44"
Wt. 4 lbs.
SOLID

HF 16.1.4-T
Ends : 1/2" Sq.
Height: 44"
Wt. 1.95 lbs.
TUBULAR

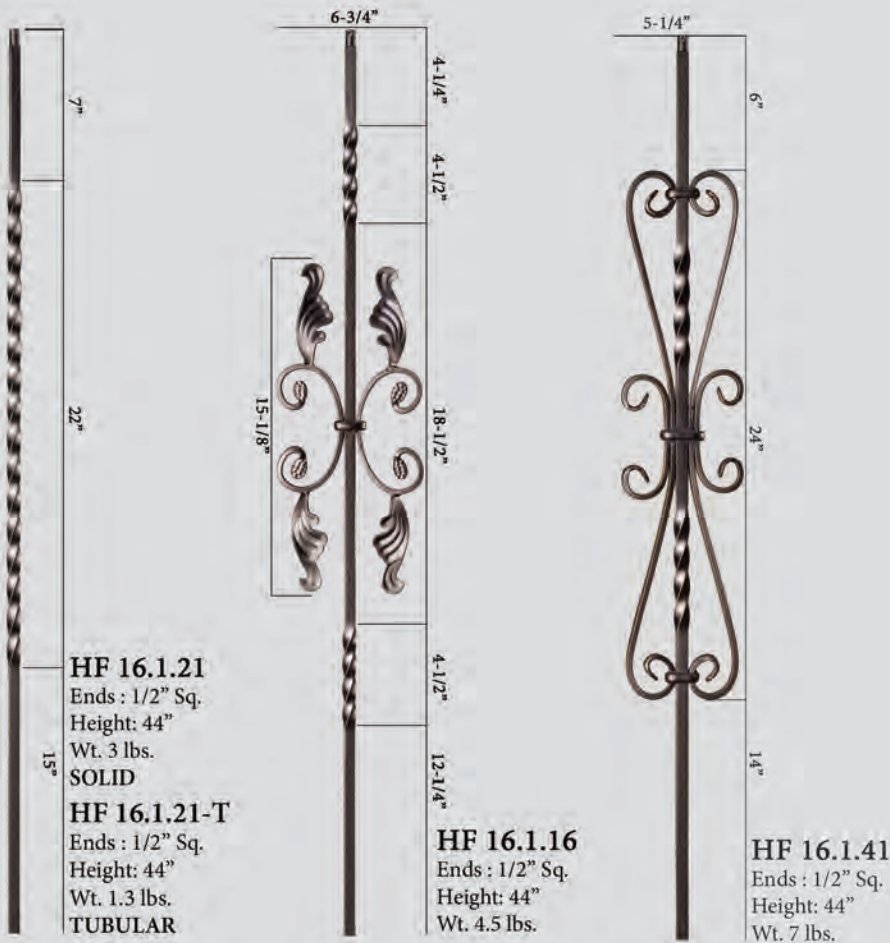

ACCESSORIES

- | | |
|-----------------------------|---------------------------------------|
| Level base shoes | HF16.3.1, HF16.3.19, HF16.3.29 |
| Level base collars | HF16.3.4, HF16.3.5, |
| Angled base shoes | HF16.3.2, HF16.3.30 |
| Adjustable level base shoes | HF16.3.44, HF16.3.46 |
| Adjustable angle base shoes | HF16.3.45, HF16.3.47 |
| Level base collars(modern) | HF16.3.9 |
| Versatile style knuckle | HF16.5.1 |
| Newel mounting kit | HF16.2.3 |

- Photos: A. A. C.
Photos: D. H.
Photos: E. G.
Photos: R.
Photos: S.
Photos: P. **NEW**
Photos: F.
Photos: T.

For photos and full accessory details see pages 62-63



ACCESSORY SPECIFICATIONS

Photo	Part #	Description	STB	AG	SP	CV	ORB	ORC	SC	GD
1/2" Square Baluster Accessories										
A.	HF16.3.1	Level base shoe, fits 1/2" square balusters, 1-5/16" square base, aluminum	•		•	•		•		
A.	HF16.3.19	Level base shoe with set screw, fits 1/2" square balusters, 1-5/16" square base, aluminum	•	•	•	•	•	•		•
E.	HF16.3.2	Angled base shoe with set screw, fits 1/2" square balusters, 1-5/16" base, aluminum	•	•	•	•	•	•		•
B.	HF16.3.21	Level base shoe with screw mount, fits 1/2" square balusters, 1-9/16" square base, aluminum	•			•				
F.	HF16.5.1	Versatile style knuckle with set screw, fits 1/2" square balusters, 1-7/16" square, aluminum	•		•	•	•	•		
C.	HF16.3.29	Oil Rubbed Bronze, level base shoe with set screw, fits 1/2" square balusters, 1-1/4" square base, cast iron	•				•			
G.	HF16.3.30	Oil Rubbed Bronze, angled base shoe with set screw, fits 1/2" square balusters, 1-1/4" base, cast iron	•				•			
D.	HF16.3.4	Level base collar, fits 1/2" square balusters, 2" square base, aluminum	•			•	•	•		
H.	HF16.3.5	Level base collar, fits 1/2" square balusters, 1-15/16" round base, aluminum, (ORB - cast iron)	•			•	•	•		
P.	HF16.3.9	Level base collar, fits 1/2" square balusters, 1-9/16" round base, cast iron	•	•		•	•			•
9/16" Square Baluster Accessories										
A.	HF16.3.3	Level base shoe, fits 9/16" square balusters, 1-5/16" square base, aluminum	•			•		•		
A.	HF16.3.20	Level base shoe with set screw, fits 9/16" square balusters, 1-5/16" square base, aluminum	•					•	•	
E.	HF16.3.17	Angled base shoe with set screw, fits 9/16" square balusters, 1-5/16" base, aluminum	•					•	•	
B.	HF16.3.22	Level base shoe with screw mount, fits 9/16" square balusters, 1-9/16" square base, aluminum	•							
C.	HF16.3.25	Level base shoe with set screw, fits 9/16" Tuscan square balusters, 1-1/4" square base, cast iron	•				•		•	
G.	HF16.3.28	Angled base shoe with set screw, fits 9/16" Tuscan square balusters, 1-1/4" base, cast iron	•				•		•	
D.	HF16.3.41	Level base collar, fits 9/16" square balusters, 2" square base, cast iron	•				•			
H.	HF16.3.42	Level base collar, fits 9/16" square balusters, 1-15/16" round base, cast iron	•				•			
P.	HF16.3.11	Level base collar, fits 9/16" square balusters, 1-3/4" round base, cast iron	•				•			
5/8" Square Baluster Accessories										
C.	HF16.3.38	Level base shoe with set screw, fits 5/8" square balusters, 1-1/4" square base, cast iron	•				•		•	
G.	HF16.3.39	Angled base shoe with set screw, fits 5/8" square balusters, 1-1/4" base, cast iron	•				•		•	
P.	HF16.3.15	Level base collar, fits 5/8" square balusters, 1-3/4" round base, cast iron	•				•			
3/4" Square Baluster Accessories										
A.	HF34.3.19	Level base shoe with set screw, fits 3/4" square balusters, 1-7/8" square base, aluminum	•	•			•			
E.	HF34.3.2	Level base shoe with set screw, fits 3/4" square balusters, 1-7/8" square base, aluminum	•	•			•			
P.	HF16.3.16	Level base collar, fits 3/4" square balusters, 2" round base, cast iron	•	•			•			
9/16" Round Baluster Accessories										
I.	HF16.3.13	Level base shoe, fits 9/16" round balusters, 1-5/16" square base, aluminum	•							
M.	HF16.3.16	Angled base shoe with set screw, fits 9/16" round balusters, 1-5/16" base, aluminum	•							
J.	HF16.3.26	Level base shoe with set screw, fits 9/16" round balusters, 1-1/4" square base, cast iron	•				•		•	
N.	HF16.3.27	Angled base shoe with set screw, fits 9/16" round balusters, 1-1/4" base, cast iron	•				•		•	
K.	HF16.3.40	Level base collar, fits 9/16" round balusters, 2" square base, cast iron	•				•			
O.	HF16.3.43	Level base collar, fits 9/16" round balusters, 1-15/16" round base, cast iron	•				•			
Q.	HF16.3.10	Level base collar, fits 9/16" round balusters, 1-9/16" round base, cast iron	•			•	•			
L.	HF17.11.22	Level base collar, fits 9/16" round stainless steel balusters, 1-1/2" round base, stainless steel								
5/8" Round Baluster Accessories										
J.	HF16.3.35	Level base shoe with set screw, fits 5/8" round balusters, 1-1/4" square base, cast iron	•	•			•		•	
N.	HF16.3.36	Angled base shoe with set screw, fits 5/8" round balusters, 1-1/4" base, cast iron	•	•			•		•	
I.	HF16.3.50	Level base shoe with set screw, fits 5/8" round balusters, 1-5/16" square base, aluminum	•				•			
M.	HF16.3.51	Angled base shoe with set screw, fits 5/8" round balusters, 1-5/16" base, aluminum	•				•			
Q.	HF16.3.12	Level base collar, fits 5/8" round balusters, 1-9/16" round base, cast iron	•	•			•			•
<i>Adjustable Shoes/Collars have a flexible insert that allows them to be used with either square or round balusters ranging in size from 1/2" to 9/16". Epoxy must be used to permanently secure.</i>										
R.	HF16.3.44	Level base shoe, fits 1/2" - 9/16" square or round balusters, 1-5/16" square base, cast iron	•				•		•	
R.	HF16.3.46	Level base shoe, fits 1/2" - 9/16" square or round balusters, 1-1/2" square base, cast iron	•				•		•	
S.	HF16.3.45	Angled base shoe, fits 1/2" - 9/16" square or round balusters, 1-5/16" base, cast iron	•				•		•	
S.	HF16.3.47	Angled base shoe, fits 1/2" - 9/16" square or round balusters, 1-1/2" base, cast iron	•				•		•	
Newel Mounting Kits										
T.	HF16.2.3	Newel mounting kit with level base shoe, fits 1-3/16" square newels, 3-1/8" square base, cast iron	•	•	•	•	•	•	•	•
T.	HF16.3.31	Newel mounting kit with level base shoe, fits 1" square newels, 3-1/8" square base, cast iron	•				•		•	
U.	HF16.3.14	Newel mounting kit with level base shoe, fits 1-3/16" round newels, 3-1/8" square base, cast iron	•	•			•		•	
U.	HF16.3.33	Newel mounting kit with level base shoe, fits 1" round newels, 3-1/8" square base, cast iron	•	•			•		•	
V.	HF17.2.3	Newel mounting kit with level base collar, fits 1-3/16" round stainless steel newels, 3-1/4" round base, stainless steel								
V2.	HF16.2.9	Newel mounting kit, fits 1-3/16" round newels, flange cover sold separately, Flange covers: STB, AG, Stainless, Brass								
Handrail Brackets										
W.	HF3002	Handrail bracket, 1-1/4" x 2-3/8" mounting plate, extends out 3" from wall, aluminum Also available in Brushed Chrome HFBC.3002, Polished Brass HFPB.3002	•	•	•	•	•	•	•	•
X.	HF3003	Handrail bracket, 2-1/16" round mounting plate, extends out 3" from wall, aluminum Also available in Chrome HFCE.3003, Brushed Chrome HFBC.3003, Nickel HFNL.3003, Polished Brass HFPB.3003	•	•	•	•	•	•	•	•

ACCESSORY PROFILES

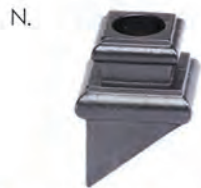
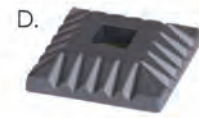

NEW

NEW



Flange Covers

Use with HF16.2.9
Newel Mounting Kit
Fits 1-3/16" Round Newels
Diameter: 4.13" Height: .7"



- SATIN BLACK HFSTB16.4.5
- ASH GREY HFAG16.4.5
- BRASS HF18.4.5
- STAINLESS STEEL HF17.4.5

Flange covers sold separately



- HFSTB-PEN
Satin Black Touch-up Pen
- HFORB-PEN
Oil Rubbed Bronze Touch-up Pen

Forged Panels

**House of Forgings
is dedicated to
providing superior
products that meet the
highest standards of
architects,
homebuilders
and homeowners.**

We are pleased to provide a full line of prefabricated ornamental iron components. These elegant products allow for the look and feel of a fully custom fabricated iron stair or railing system. In addition to cost savings, installation time is greatly reduced compared to traditional fabrication.

STAIR & RAILING PRODUCTS BY





Rebecca panels paired with Monte Carlo balusters (shown)

REBECCA



Rebecca HFRB.A1 (shown)

5/8" ROUND IRON



1/2" ROUND IRON

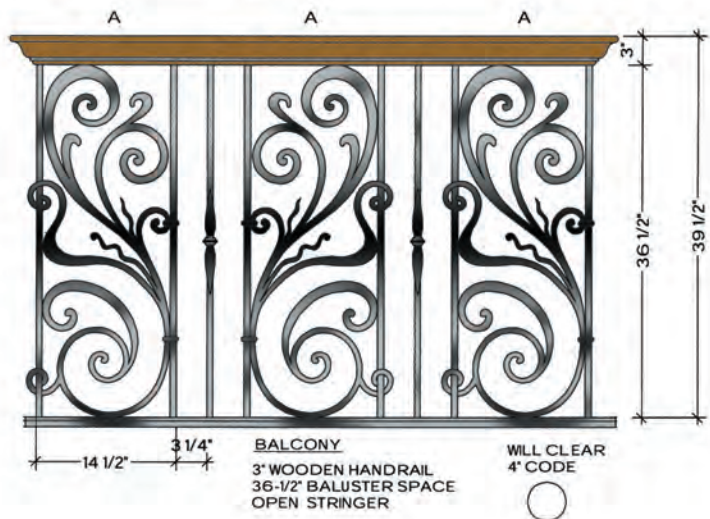
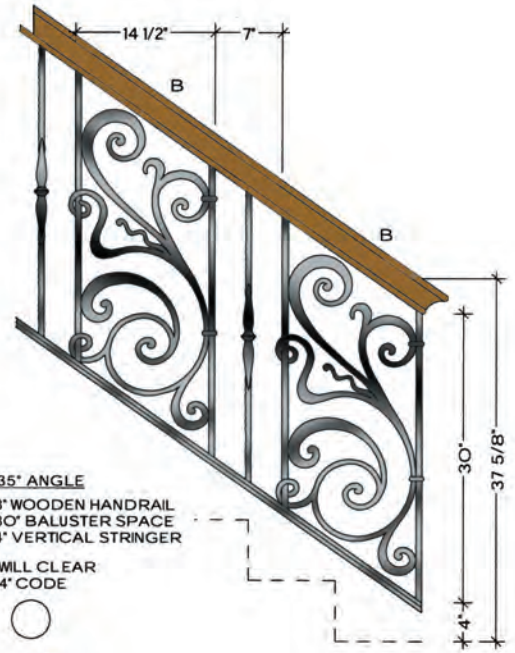

REBECCA

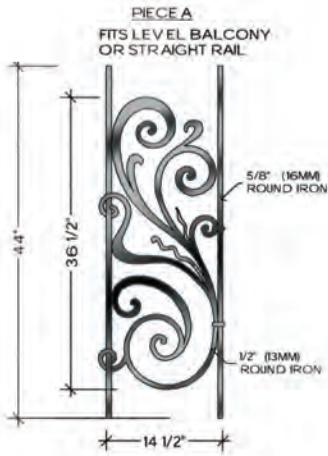

TOP VIEW
A-1
FLAT
HFRB.A1

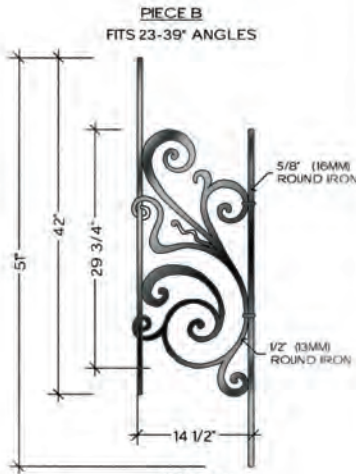

TOP VIEW
B-1
FLAT
HFRB.B1

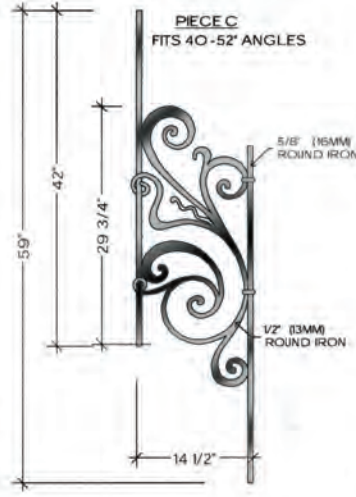

TOP VIEW
C-1
FLAT
HFRB.C1

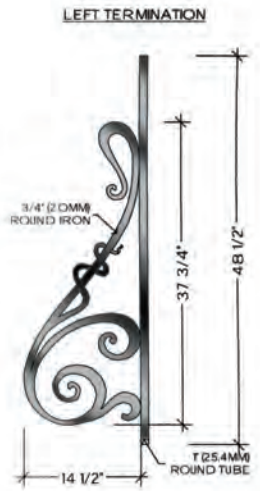

TOP VIEW
4 1/2" RADIUS
HFRB.TERM LF

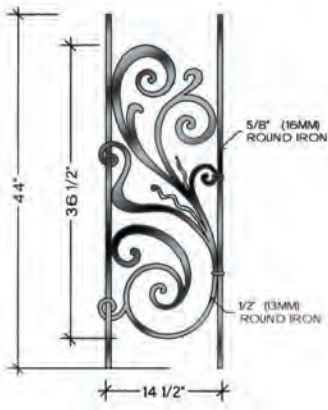

TOP VIEW
A-2
ALL RADIUS FROM 28" TO 20"-O"
HFRB.A2

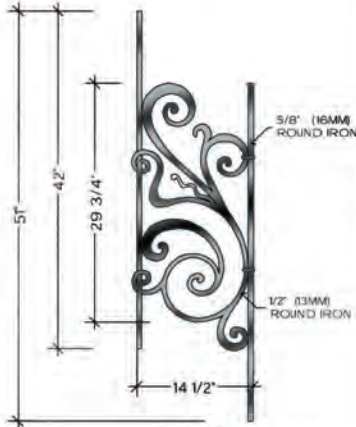

TOP VIEW
B-2
ALL RADIUS FROM 30" TO 20"-O"
HFRB.B2

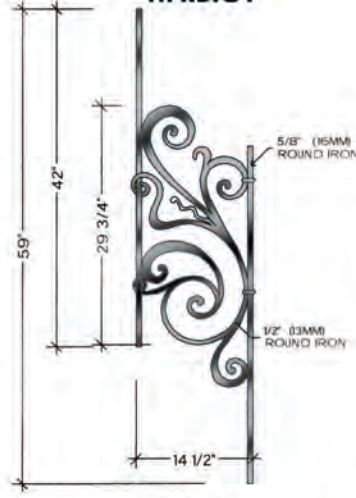

TOP VIEW
C-2
ALL RADIUS FROM 30" TO 20"-O"
HFRB.C2

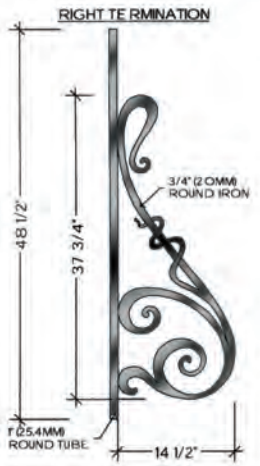

TOP VIEW
4 1/2" RADIUS
HFRB.TERM RT

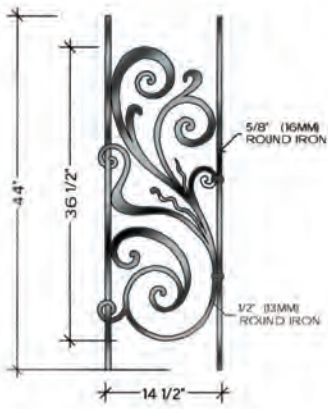

TOP VIEW
A-3
ALL RADIUS FROM 28" TO 20"-O"
HFRB.A3

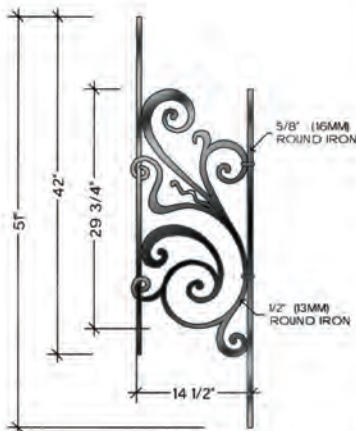

TOP VIEW
B-3
ALL RADIUS FROM 30" TO 20"-O"
HFRB.B3

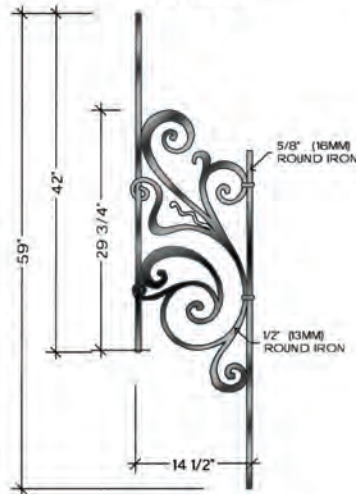

TOP VIEW
C-3
ALL RADIUS FROM 30" TO 20"-O"
HFRB.C3

TUSCANY



Tuscany HFTU.A1 (shown)

1/2" SQUARE
IRON

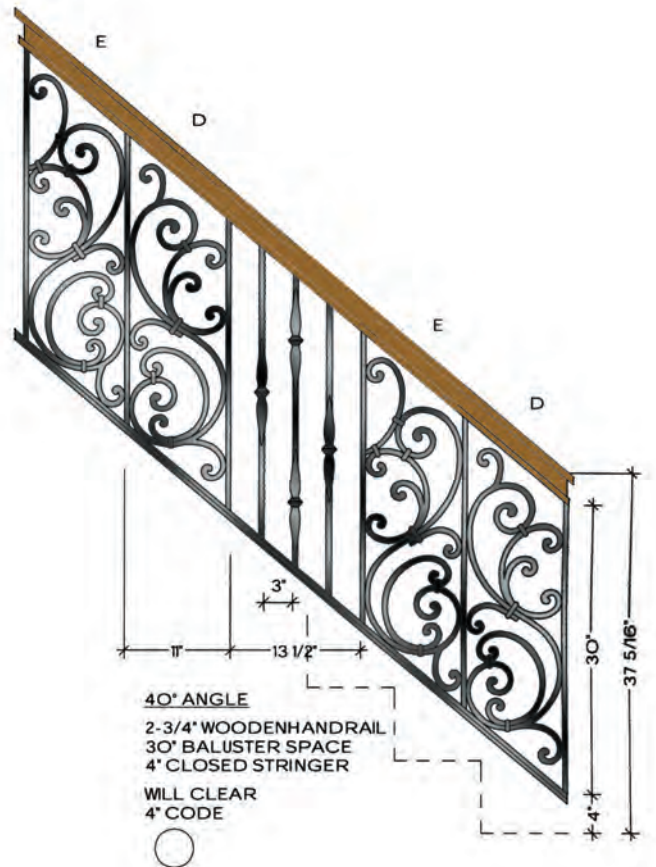
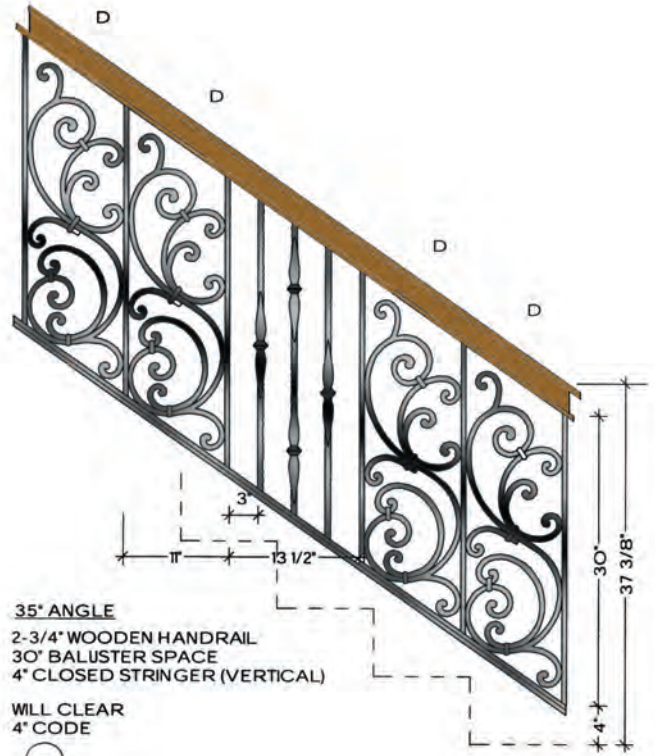

TUSCANY

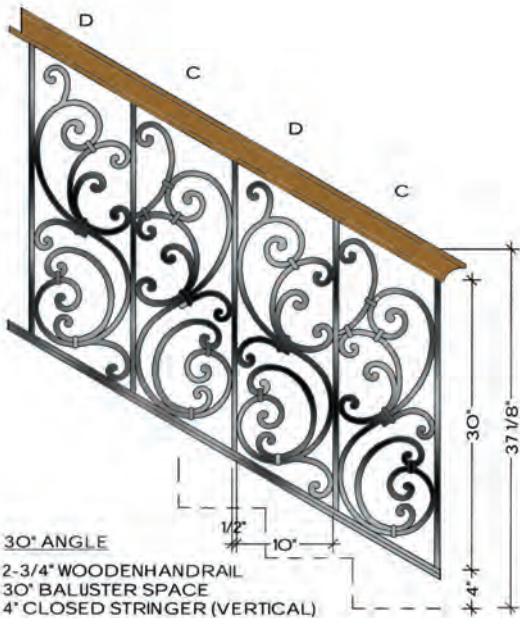

WILL CLEAR
 4" CODE



40° ANGLE

WILL CLEAR
 4" CODE



RIGHT TERMINATION
 LEFT SIDE VIEW

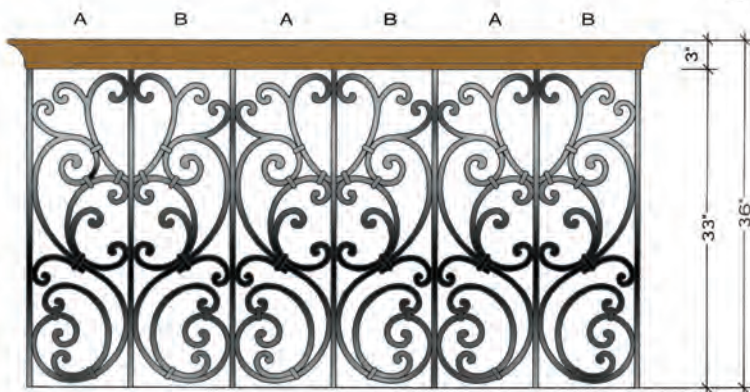

1/2" 10"

BALCONY

3" WOODEN HANDRAIL
 33" BALUSTER SPACE

WILL CLEAR
 4" CODE

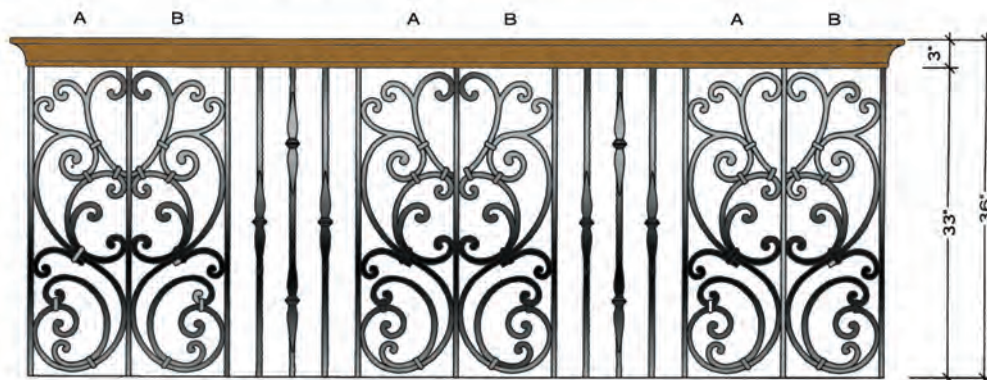

1/2" 10" 1/2" 3"

14 1/2"

BALCONY

3" WOODEN HANDRAIL
 33" BALUSTER SPACE

WILL CLEAR
 4" CODE



TUSCANY

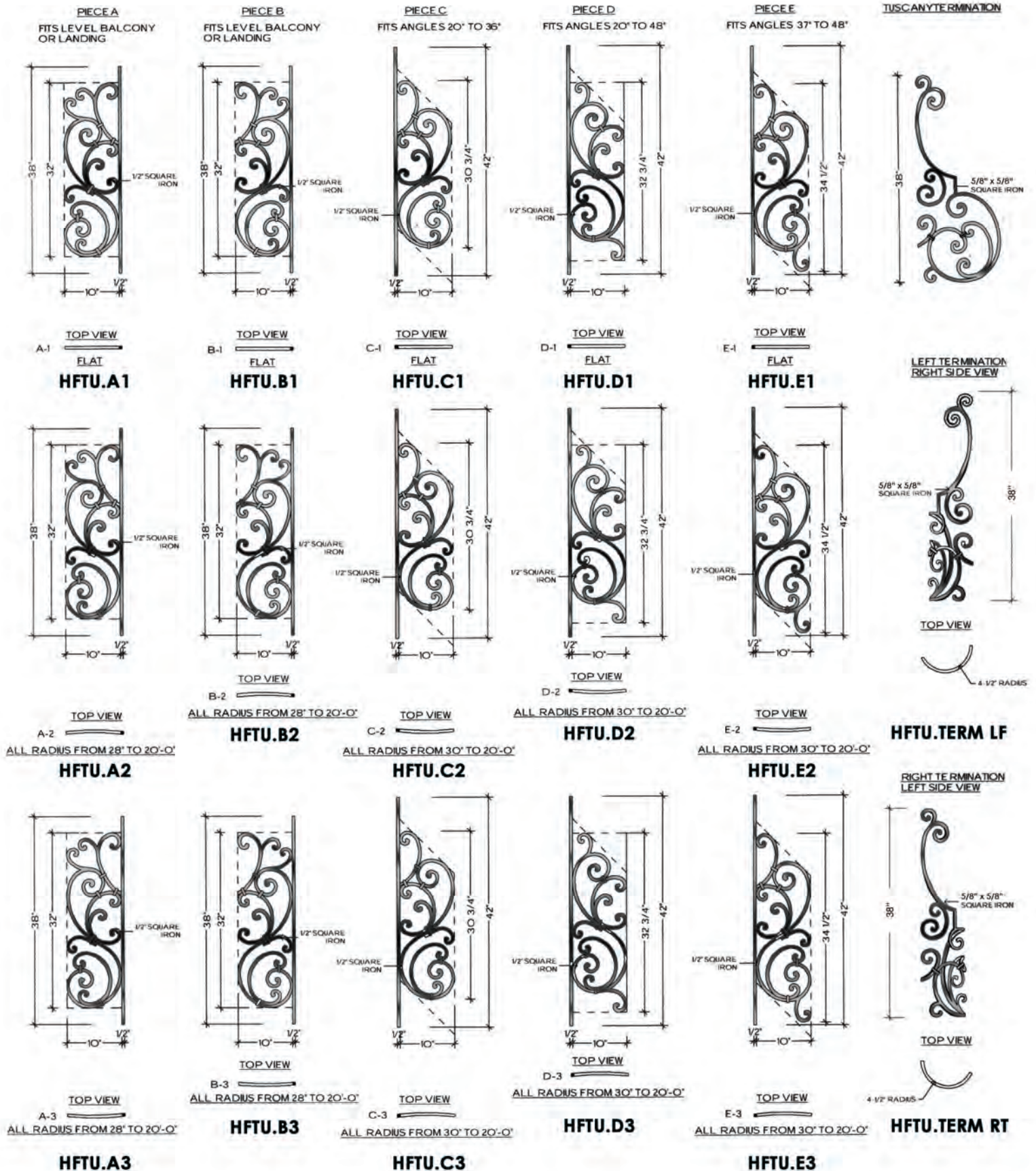



Tuscany panels paired with Gothic balusters (shown)

SEVILLE



Seville HFSE.A1 (shown)

1/2" SQUARE IRON



45° ANGLE
2-1/2' WOODEN HANDRAIL
30" BALUSTER SPACE
4" VERTICAL STRINGER

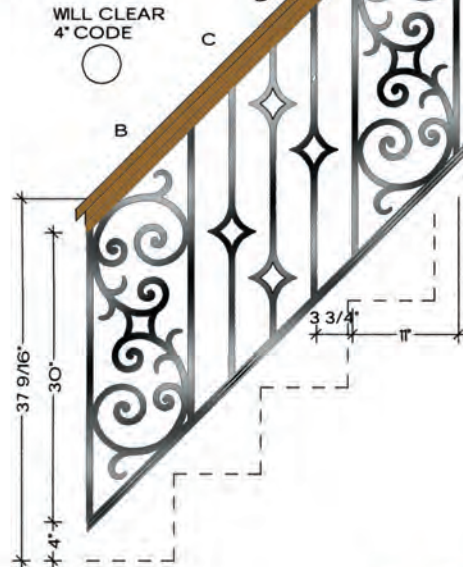

30° ANGLE
3' WOODEN HANDRAIL
30" BALUSTER SPACE
4" VERTICAL STRINGER

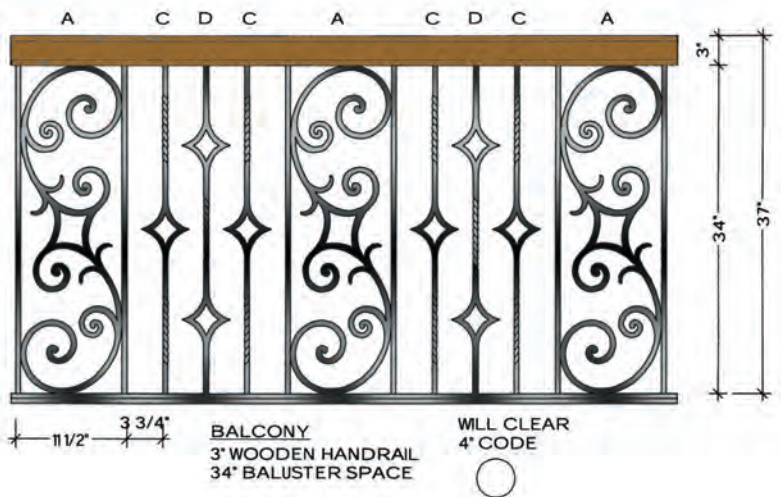
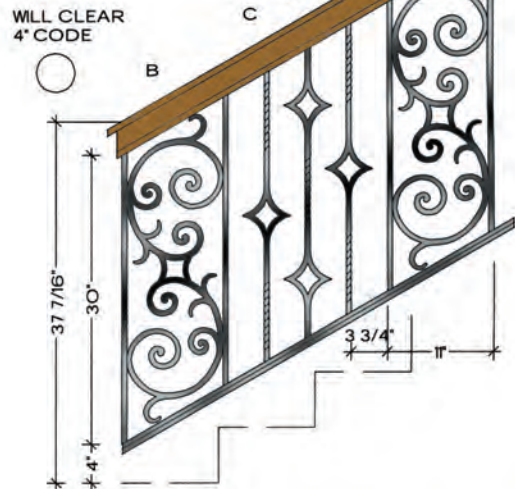

SEVILLE

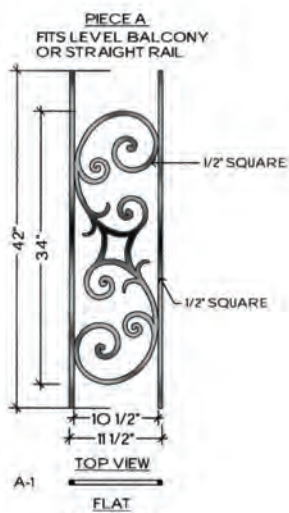

HFSE.A1

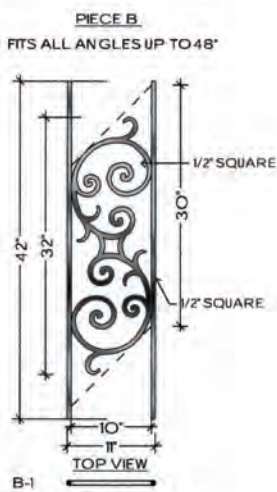

HFSE.B1

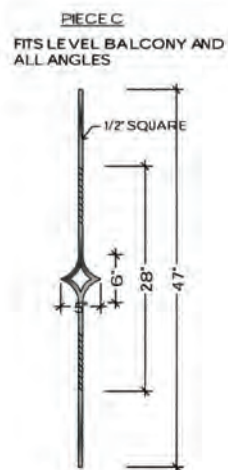

HFSE.C

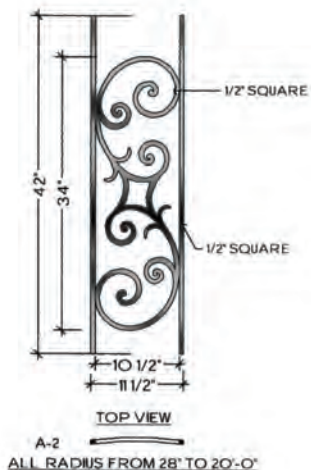

ALL RADIUS FROM 28" TO 20'-0"

HFSE.A2

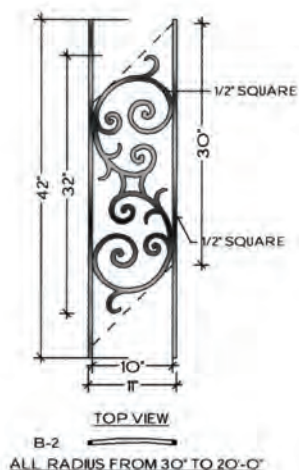

ALL RADIUS FROM 30" TO 20'-0"

HFSE.B2

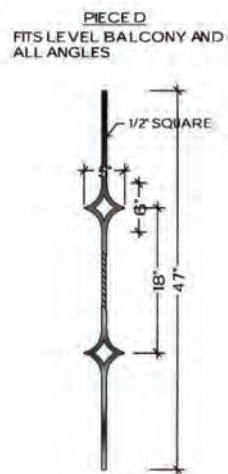

HFSE.D

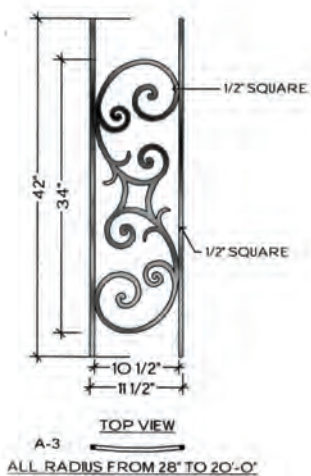

ALL RADIUS FROM 28" TO 20'-0"

HFSE.A3

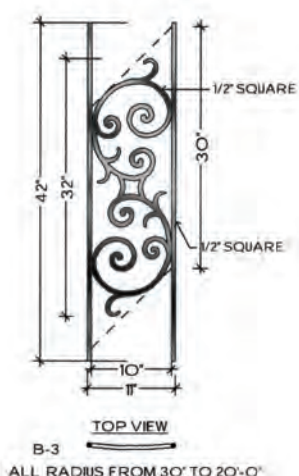

ALL RADIUS FROM 30" TO 20'-0"

HFSE.B3

MILANO



Milano HFMO.A1 (shown)

3/4" SQUARE
TUBE



1/2" SQUARE
IRON

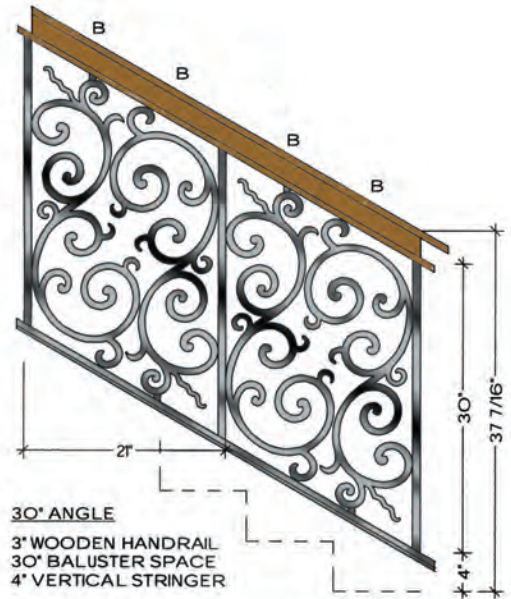

30° ANGLE
3" WOODEN HANDRAIL
30° BALUSTER SPACE
4" VERTICAL STRINGER

WILL CLEAR
4" CODE



***NOTE: THE MILANO LAYOUT
REQUIRES THE REMOVAL OF
SOME ATTACHED SCROLLS AND
REWELDING SCROLLS TO
PREVIOUS VERTICAL***

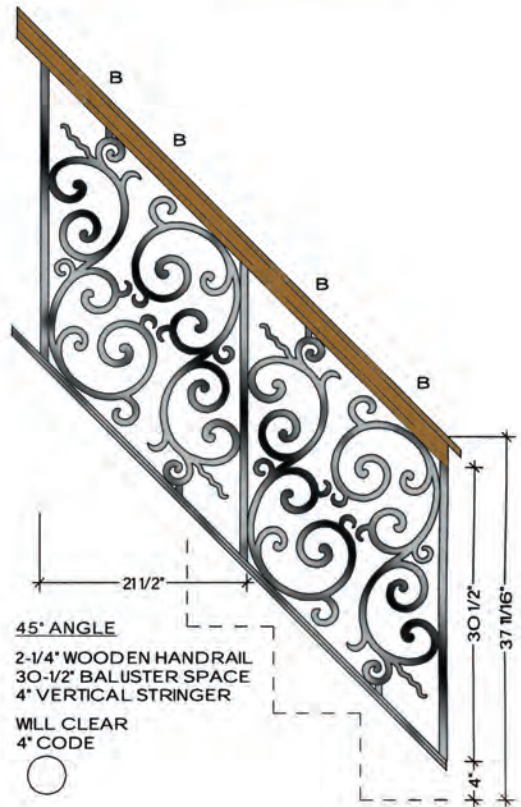

45° ANGLE
2-1/4" WOODEN HANDRAIL
30-1/2° BALUSTER SPACE
4" VERTICAL STRINGER

WILL CLEAR
4" CODE



MILANO

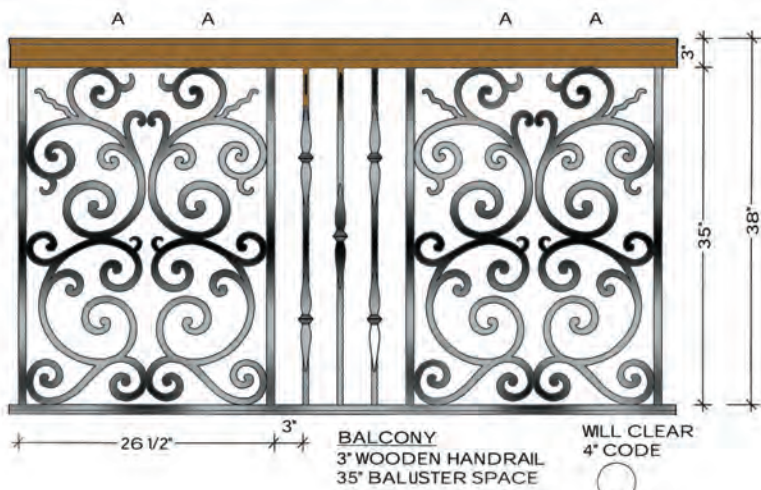
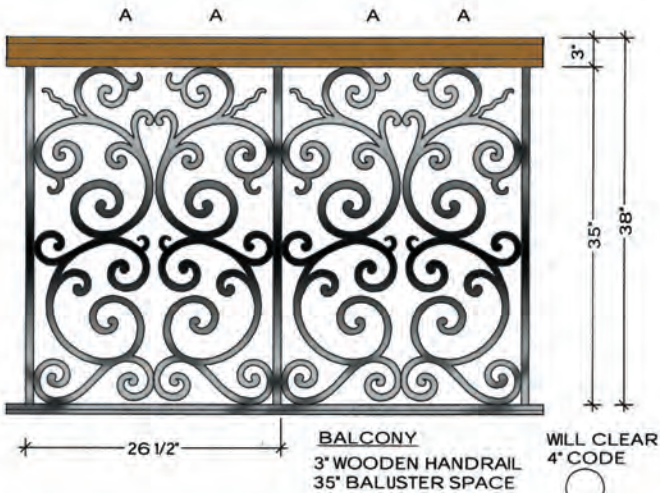
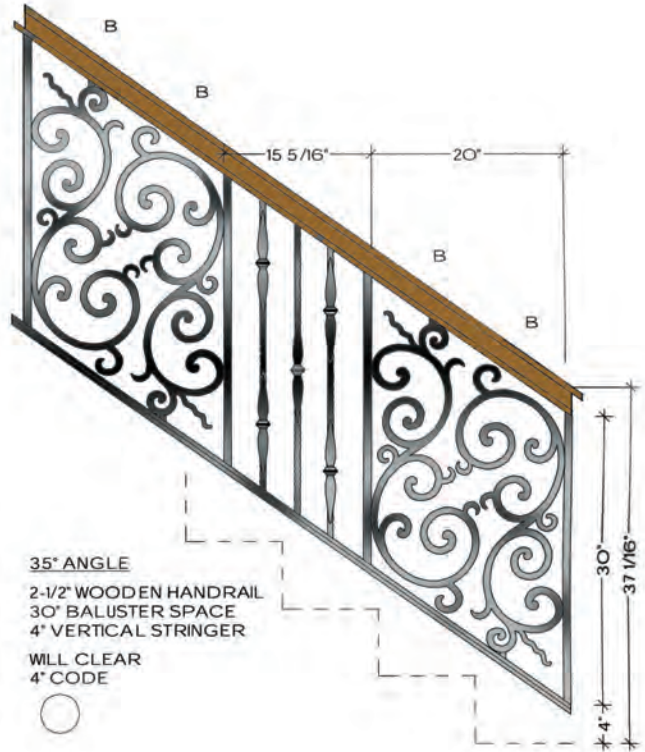
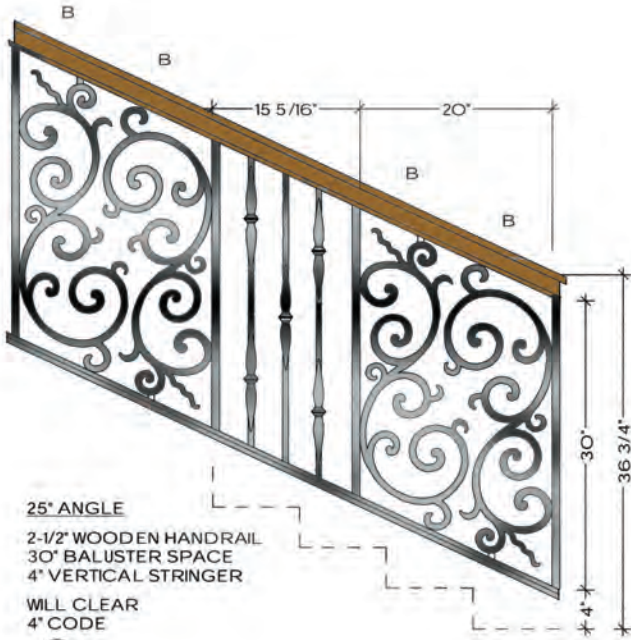

MILANO

PIECE A
FITS LEVEL BALCONY OR LANDING

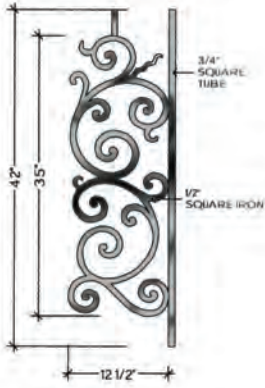

TOP VIEW
FLAT
A-1
HFMO.A1

PIECE B
FITS ALL ANGLES UP TO 48°

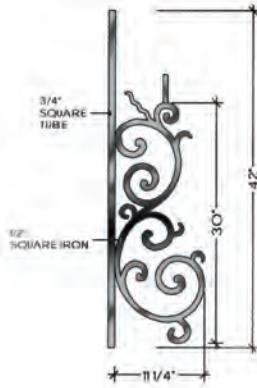

TOP VIEW
FLAT
B-1
HFMO.B1

PIECE B
FITS ALL ANGLES UP TO 48°

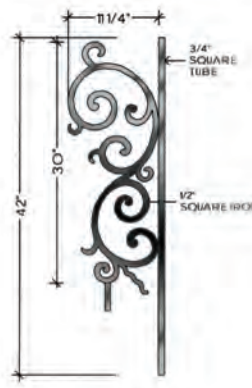

TOP VIEW
FLAT
B-1
HFMO.B1

TERMINATION

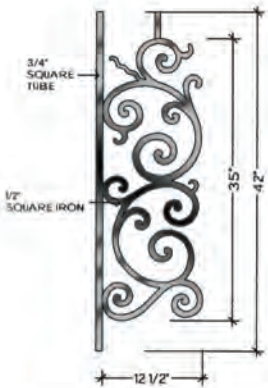
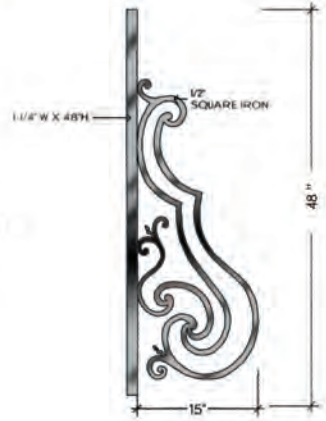

TOP VIEW
A-2
ALL RADIUS FROM 28" TO 20'-0"
HFMO.A2

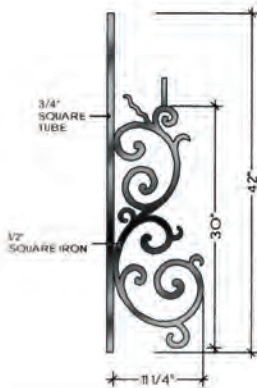

TOP VIEW
B-2
ALL RADIUS FROM 30" TO 20'-0"
HFMO.B2

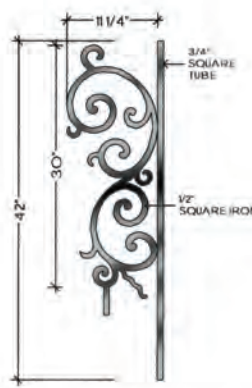

TOP VIEW
B-2
ALL RADIUS FROM 30" TO 20'-0"
HFMO.B2

LEFT TERMINATION
RIGHT SIDE VIEW



HFMO.TERM LF
RIGHT TERMINATION
LEFT SIDE VIEW

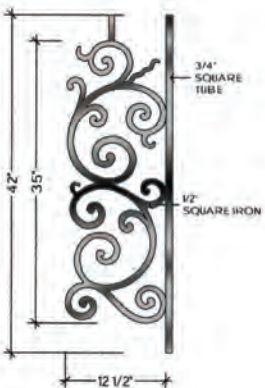

TOP VIEW
A-3
ALL RADIUS FROM 28" TO 20'-0"
HFMO.A3

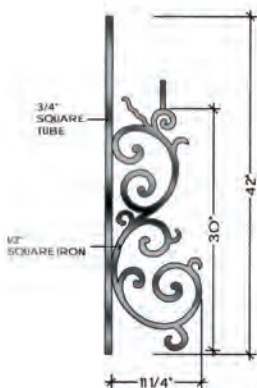

TOP VIEW
B-3
ALL RADIUS FROM 30" TO 20'-0"
HFMO.B3

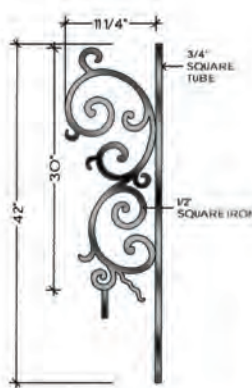

TOP VIEW
B-3
ALL RADIUS FROM 30" TO 20'-0"
HFMO.B3



HFMO.TERM RT



BORDEAUX



Bordeaux HFBX.A1 (shown)

3/4" SQUARE
TUBE



5/8" SQUARE
IRON

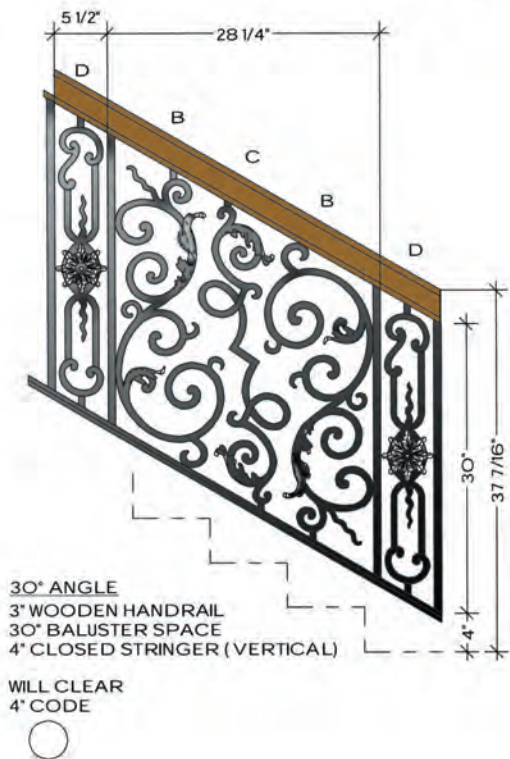
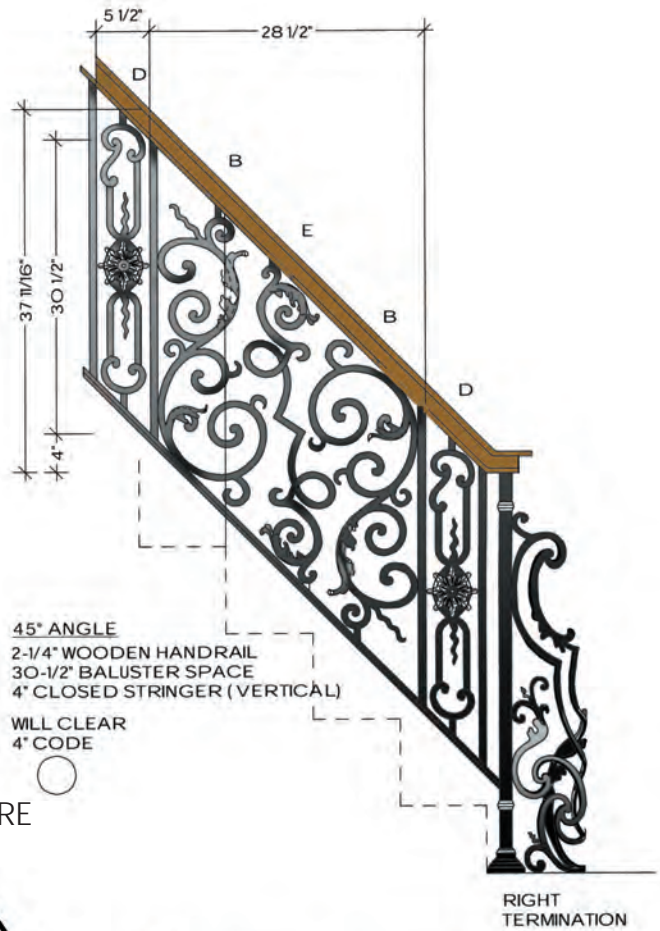

BORDEAUX

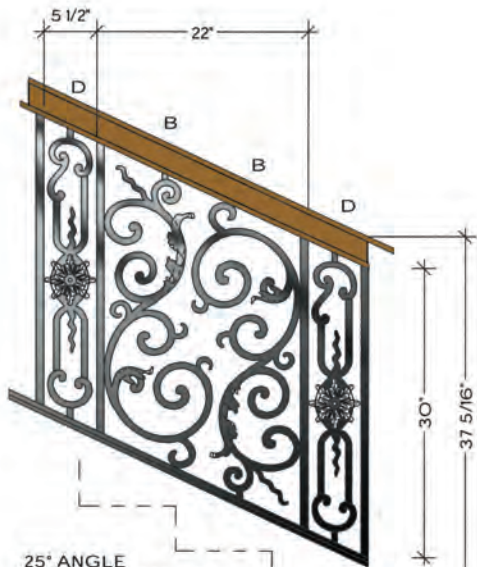

25° ANGLE
 3" WOODEN HANDRAIL
 30" BALUSTER SPACE
 4" CLOSED STRINGER (VERTICAL)

WILL CLEAR
 4" CODE

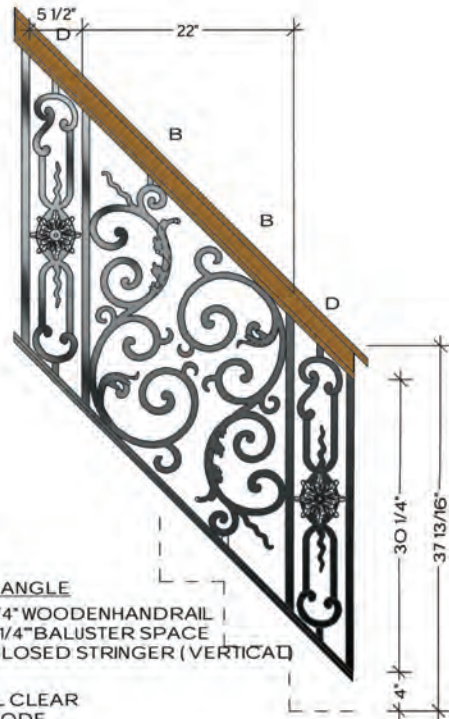

45° ANGLE
 2-3/4" WOODEN HANDRAIL
 30-1/4" BALUSTER SPACE
 4" CLOSED STRINGER (VERTICAL)

WILL CLEAR
 4" CODE

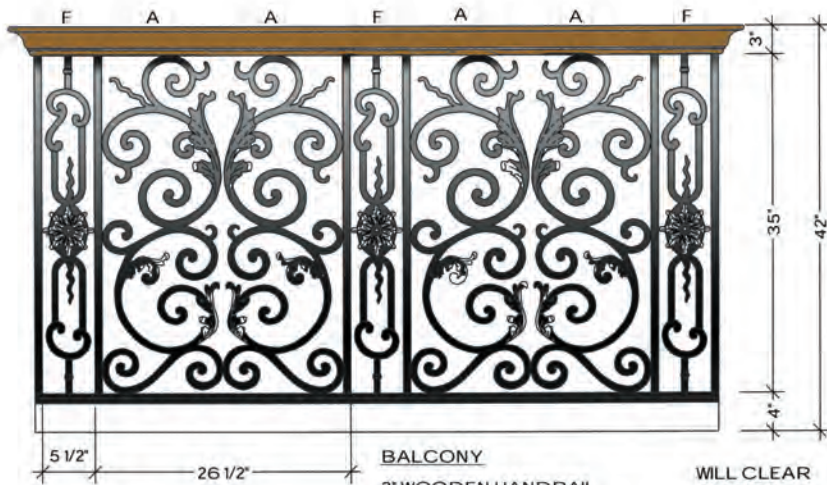

BALCONY
 3" WOODEN HANDRAIL
 35" BALUSTER SPACE
 4" CLOSED STRINGER

WILL CLEAR
 4" CODE



BORDEAUX

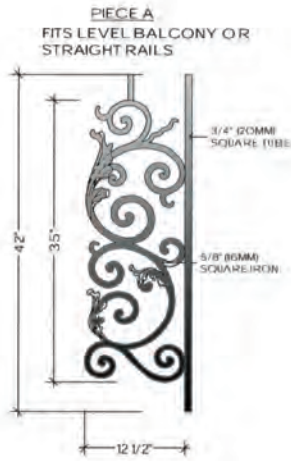

TOP VIEW
A-1
FLAT
HFBX.A1

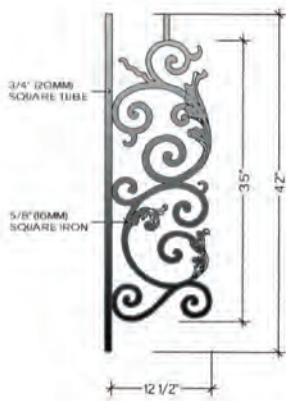

TOP VIEW
A-2
ALL RADIUS FROM 28" TO 20'-0"
HFBX.A2

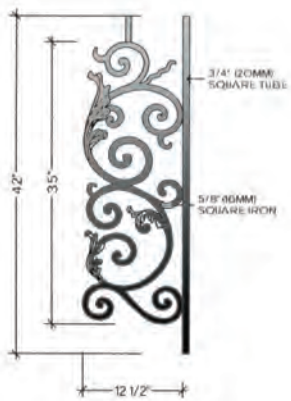

TOP VIEW
A-3
ALL RADIUS FROM 28" TO 20'-0"
HFBX.A3

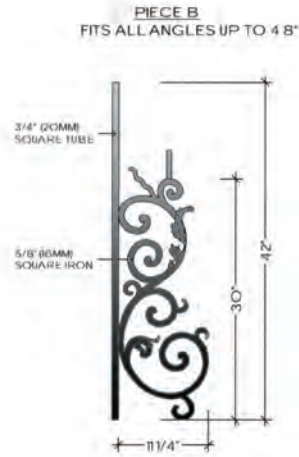

TOP VIEW
B-1
FLAT
HFBX.B1

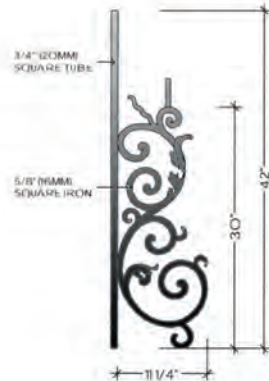

TOP VIEW
B-2
ALL RADIUS FROM 30" TO 20'-0"
HFBX.B2

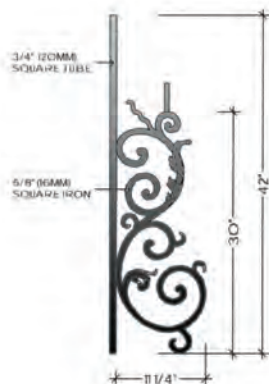

TOP VIEW
B-3
ALL RADIUS FROM 30" TO 20'-0"
HFBX.B3

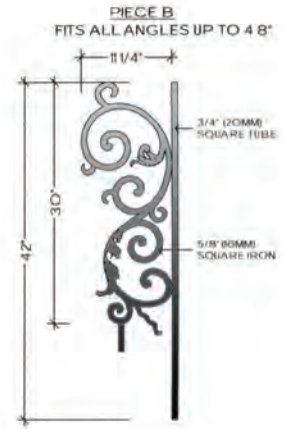

TOP VIEW
B-1
FLAT
HFBX.B1

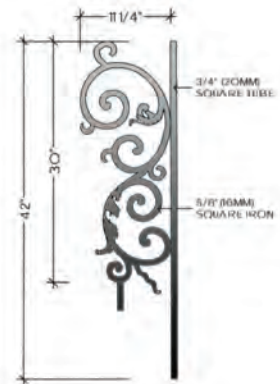

TOP VIEW
B-2
ALL RADIUS FROM 30" TO 20'-0"
HFBX.B2

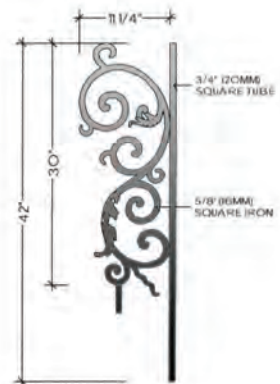

TOP VIEW
B-3
ALL RADIUS FROM 30" TO 20'-0"
HFBX.B3

BORDEAUX

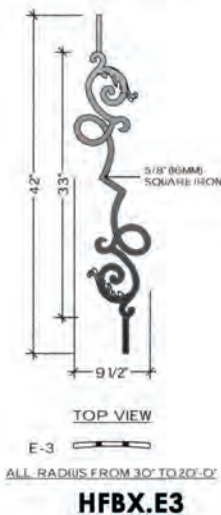
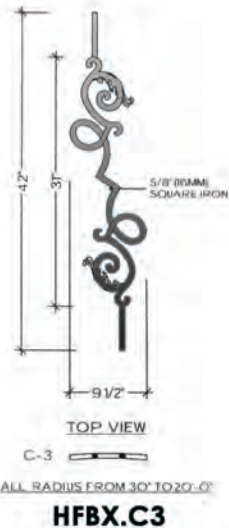
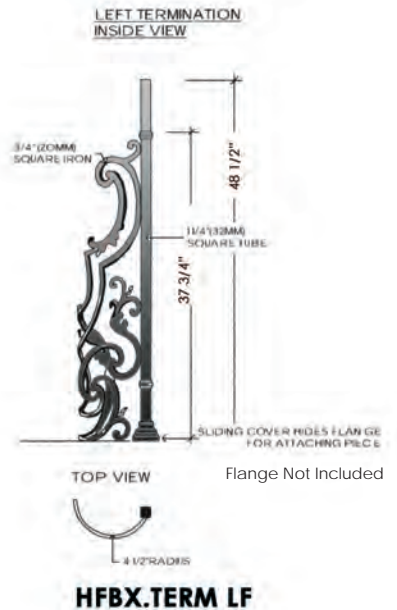
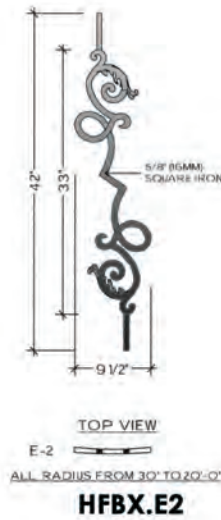
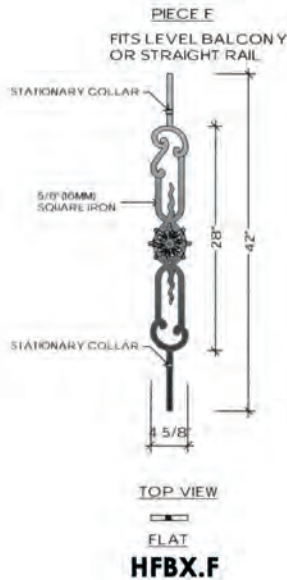
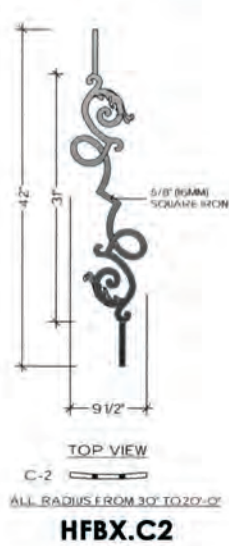
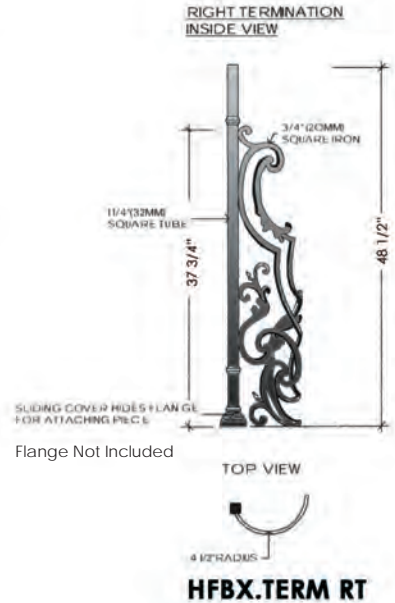
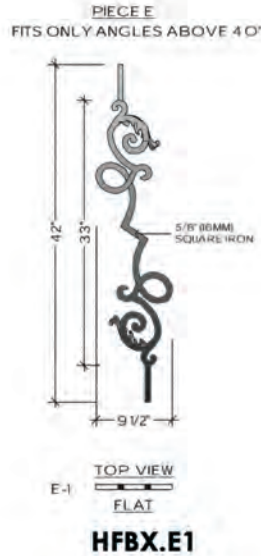
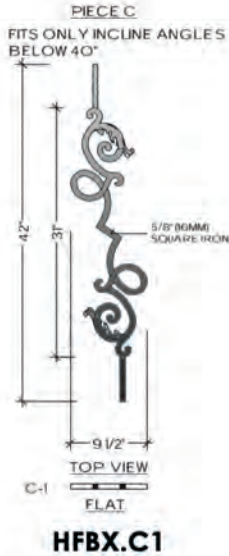

REGENCY



Regency HFRE.A1 (shown)

1" SQUARE TUBE



3/8" X 1" FLAT IRON

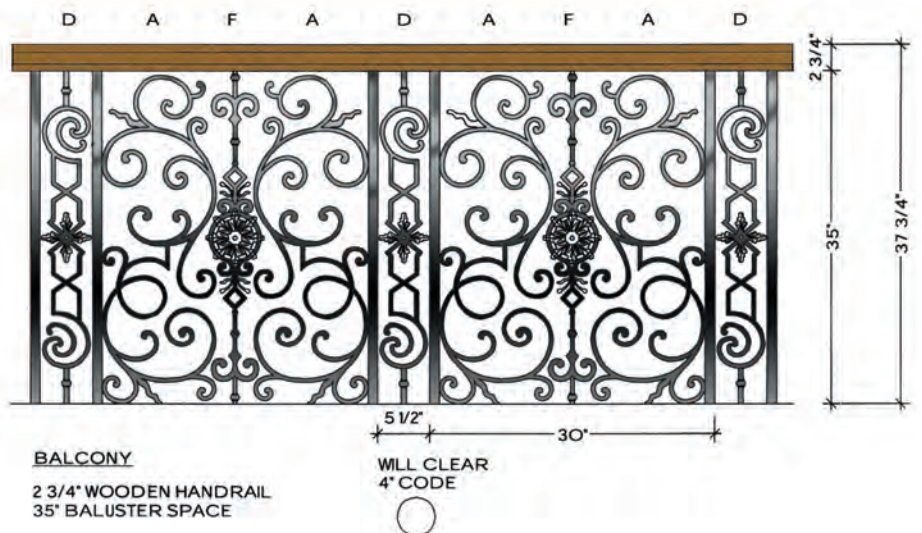
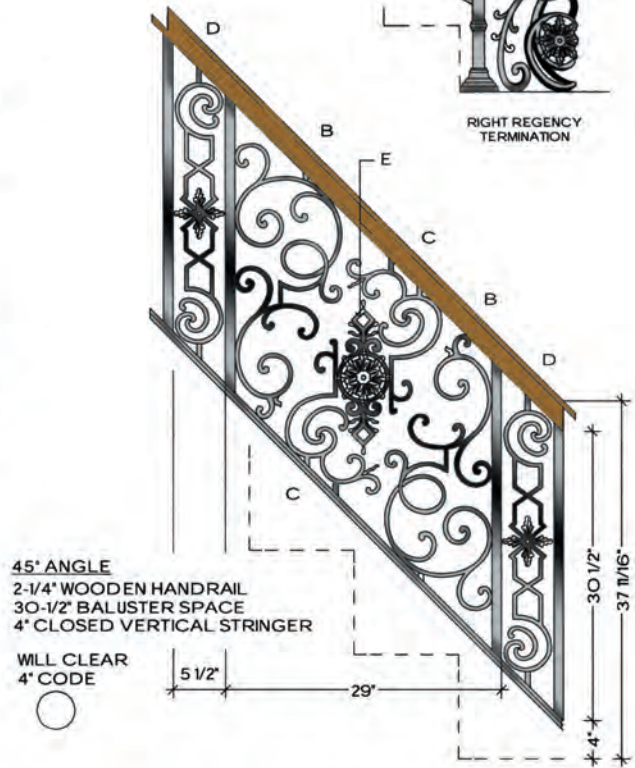

REGENCY

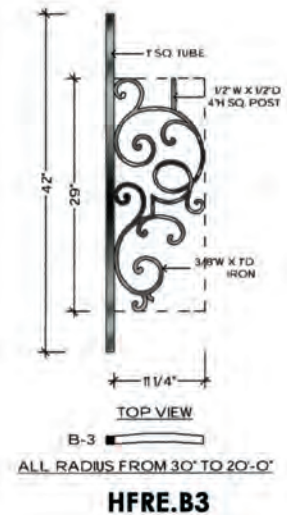
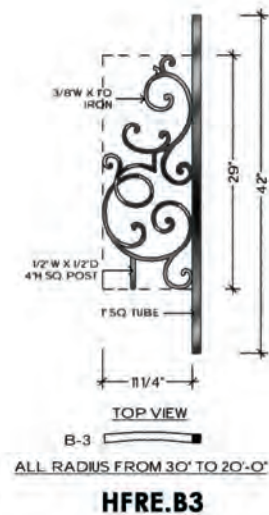
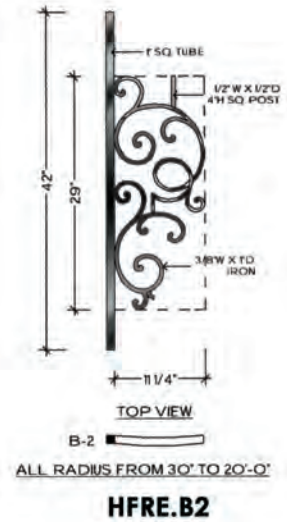
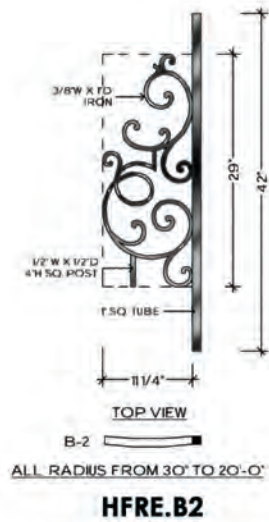
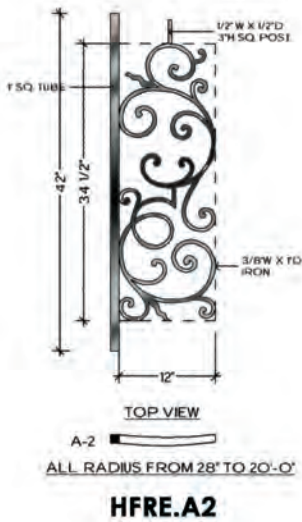
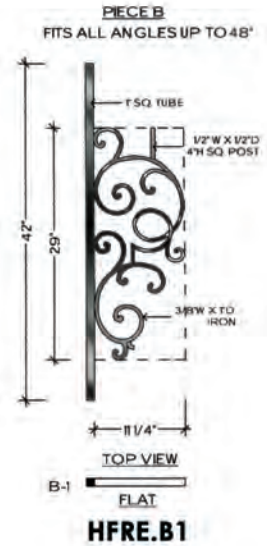
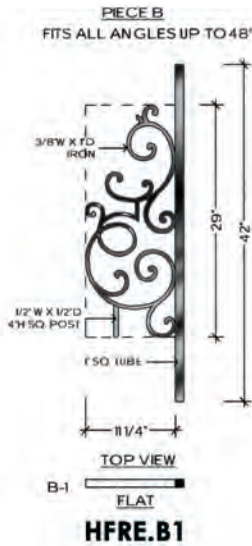
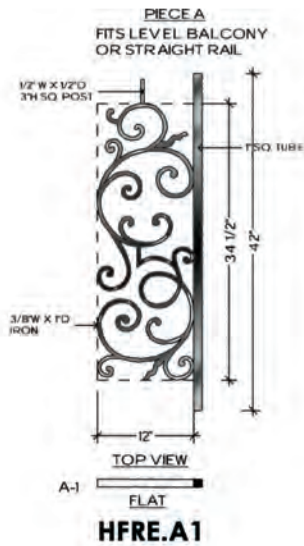

REGENCY

PIECE C
FITS ALL ANGLES UP TO 48°

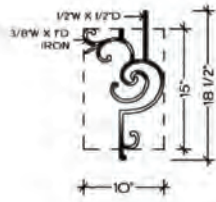

TOP VIEW
C-1
FLAT
HFRE.C1

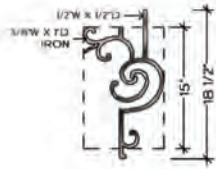

TOP VIEW
C-2
ALL RADIUS FROM 30" TO 20"-0"
HFRE.C2

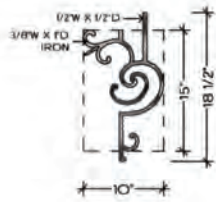

TOP VIEW
C-3
ALL RADIUS FROM 30" TO 20"-0"
HFRE.C3

PIECE C
FITS ALL ANGLES UP TO 48°

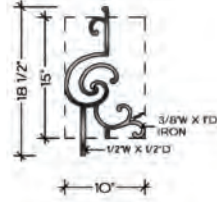

TOP VIEW
C-1
FLAT
HFRE.C1

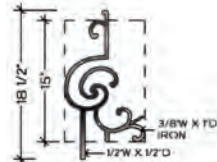

TOP VIEW
C-2
ALL RADIUS FROM 30" TO 20"-0"
HFRE.C2

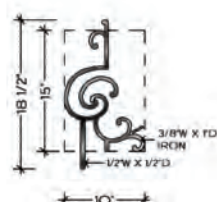

TOP VIEW
C-3
ALL RADIUS FROM 30" TO 20"-0"
HFRE.C3

LEFT SIDE TERMINATION
RIGHT SIDE VIEW

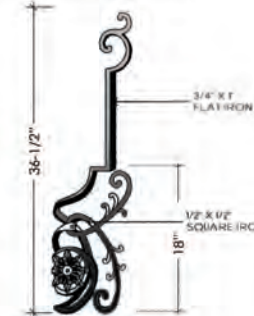

HFRE.TERM LF

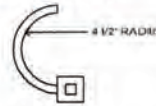

RIGHT SIDE TERMINATION
LEFT SIDE VIEW

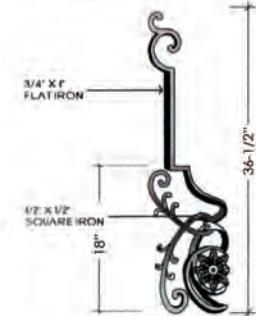

HFRE.TERM RT

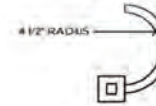

TERMINATION



PIECE D
FITS ALL ANGLES &
LEVEL BALCONY



TOP VIEW
FLAT
HFRE.D

PIECE E
FITS ALL ANGLES

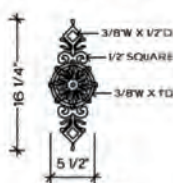

HFRE.E

PIECE F
FITS LEVEL BALCONY
OR STRAIGHT RAIL

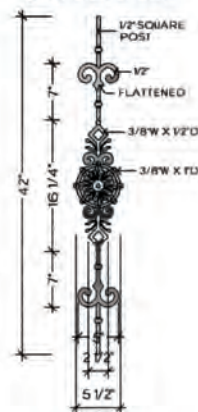

TOP VIEW
FLAT
HFRE.F



U.S. Pat.
No. 5,820,111
No. 6,059,269

Regency panels (shown)

Regency ©
85

Wood Products

**At House of Forgings
we provide much
more than just forged
iron products, we
boast an extensive
line of wood
components
as well.**

From handrails to treads, we carry virtually all components necessary to create the staircase or balcony you have envisioned. All products are stocked in Red Oak or Paint Grade, ready for immediate shipping. Components are packaged and shipped with the utmost integrity ensuring that your order will arrive on time and undamaged.

STAIR & RAILING PRODUCTS BY



**HOUSE OF
FORGINGS**



Magnolia newels (RO-4040) paired with Aalto balusters in Satin Black (HFSTB16.6.3) (shown)



FORESTKRAFT™

WOOD STAIR & RAILING PRODUCTS



Box Newels

Non removable caps - Stocked in Red Oak and White Oak



Modern
Box Newel
Small
4400
HT. 56"
W = 3-1/4"
SOLID



Modern
Box Newel
Large
5400
HT. 56"
W = 5-1/2"
SOLID



Shown with
optional base
4-1/2" x 21-3/4"
(sold separately)
BASE-4000



Shown with
optional base
6-1/2" x 21-3/4"
(sold separately)
BASE-5000

Routed Newels

Non removable caps - Stocked in Red Oak and White Oak



Modern
Routed Newel
4900
HT. 56"
W = 3-1/4"
SOLID



Modern
Routed Newel
5900
HT. 56"
W = 5-1/2"
SOLID



Shown with
optional base
4-1/2" x 21-3/4"
(sold separately)
BASE-4000



Shown with
optional base
6-1/2" x 21-3/4"
(sold separately)
BASE-5000

Blank Newel Caps

Available for: 3-1/4" and 5-1/2" blank newels
 Stocked in Red Oak and White Oak - Sold separately



Size	SQUARE	PYRAMID	STACKED	COVE
3-1/4" Square Newels	SQUARE CAP-4000 HT. 1-3/4" W= 3-1/4"	PYRAMID CAP-4000 HT. 1-9/16" W= 3-1/4"	STACKED CAP-4000 HT. 2-1/4" W= 3-1/4"	COVE CAP-4000 HT. 2-1/2" W= 4-5/8"
5-1/2" Square Newels	SQUARE CAP-5000 HT. 2" W= 5-1/2"	PYRAMID CAP-5000 HT. 1-5/8" W= 5-1/2"	STACKED CAP-5000 HT. 2-3/4" W= 5-1/2"	COVE CAP-5000 HT. 2-7/8" W= 6-7/8"

Newel Bases

Stocked in Red Oak and White Oak



Blank Newels

Stocked in Red Oak and White Oak



Blank Newel Options: Caps / Bases

3-1/4" and 5-1/2" blank newels shown with optional bases and caps - sold separately
 Additional configuration options available.



BLANKS



4005
HT. 54"
W = 3-1/4"



4007
HT. 54"
W = 3-1/4"



Prefinished white
4923-41
HT. 41"
W = 1-3/4"
***4913-41**
HT. 41"
W = 1-1/4"

* SPECIAL ORDER IN RED OAK

CLASSIC



5140
HT. 48"
W = 3-1/4"



4140-SP
HT. 48"
W = 3"
STABILIZER
NEWEL



5160
HT. 54"
W = 3-1/4"



5170
HT. 54"
W = 3-1/4"

CLASSIC



Prefinished white
4121-41
HT. 41"
W = 1-1/4"

* SPECIAL ORDER



Prefinished white
4120-41
HT. 41"
W = 1-3/4"



Prefinished white
4220-41
HT. 41"
W = 2-1/4"

* SPECIAL ORDER



Prefinished white
5067-36
HT. 36"
W = 1-1/4"

5067-39
HT. 39"
W = 1-1/4"

5067-41
HT. 41"
W = 1-1/4"

MAGNOLIA



CONCORD



REMINGTON



*SPECIAL ORDER

Wood Products

All wood products are stocked in Red Oak (RO) or Prefinished White (PG) unless otherwise noted.

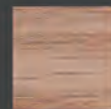

Red Oak (RO)

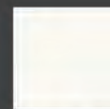

Prefinished White (PG)

Domestic and Exotic Wood Species

All wood products in non-stock species are available by special order.



Maple

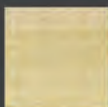

Poplar

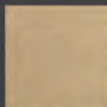

White Oak



Walnut



Hickory/Pecan



Clear Alder

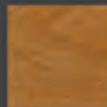

American Cherry



Mahogany



BOX NEWELS



Contemporary Box Newel
4191
 HT. 56"
 W = 3-1/4"
SOLID



Stabilizer newels are pre drilled 1/2" x 2-1/8" (7/16" x 3" dowel included)

Contemporary Stabilizer Newel
4191-SP
 HT. 43"
 W = 3"
SOLID



Plain Box Newel
961-56
 HT. 56"
 W = 4-1/2"
SOLID



Recessed Panel Box Newel
4291
 HT. 56"
 W = 6"
HOLLOW



All box newels come with both square and pyramid tops

BOX NEWELS



Adjustable Box Newel
4592
 HT. 56"
 W = 5"
SOLID
Plain Box Newel
4691
 HT. 56"
 W = 6-1/4"
HOLLOW



Plain Newel
4592-PLAIN
 HT. 56"
 W = 3-1/2"
SOLID



Stabilizer newels are pre drilled 1/2" x 2-1/8" (7/16" x 3" dowel included)

Stabilizer Newel
4592-SP
 HT. 43"
 W = 3"
SOLID



Raised Panel Box Newel
4791
 HT. 56"
 W = 6-1/4"
HOLLOW



Fluted Box Newel
4891
 HT. 56"
 W = 6-1/4"
HOLLOW



Recessed Panel Box Newel
4991
 HT. 56"
 W = 6-1/4"
HOLLOW

All box newels stocked in Red Oak (RO)



RO-4691 Box Newel and 4923-41 Balusters (shown)



RO-4191 Box Newels paired with Versatile balusters (shown)



RO-4291 Box Newels paired with Versatile balusters (shown)

HANDRAIL & FITTINGS

6040



6040
Round Wall Rail
Diameter: 1-5/8"

RETURNED END



 7009
 7209

6010



6010 Straight Rail
6010-B Bending Rail
bending rail includes moulding

OPENING CAP



 7019
 7219

Colonial Hand Rail
HT. 2-3/8"
W. 2-1/4"



6210



6210 Straight Rail
6210-B Bending Rail
bending rail includes moulding

TANDEM CAP



 7020
 7220

Traditional Hand Rail
HT. 2-3/8"
W. 2-5/8"

6084



6084 Straight Rail
6084-B Bending Rail
no fittings available

OVER EASING



 7013
 7213

Modern Hand Rail
HT. 1-5/8"
W. 2-5/8"

6002

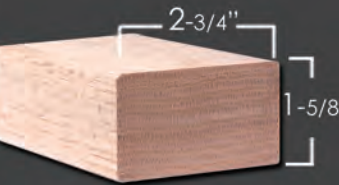

6002 Straight Rail
6002-B Bending Rail
no fittings available

UP EASING 90 DEGREE



 7012  7014
 7212  7214

Modern Hand Rail
HT. 1-5/8"
W. 2-3/4"

6060

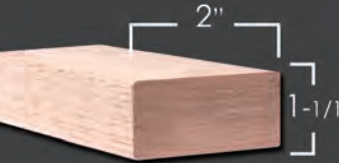

6060 Straight Rail
no fittings available

START EASING WITH CAP



 7010
 7210

Modern Hand Rail
HT. 1-1/16"
W. 2"

All handrail and fittings stocked in Red Oak (RO)



All handrail and fillings stocked in Red Oak (RO)

TREADS/STEPS/LUMBER/PLY

TREADS

RO-8070

Red Oak Bull Nose Tread
1-1/16" x 11-1/2" x 42, 48, 54,
60, 72, 84, 96"



CLASSIC TREADS

RO-8070-13 x

Red Oak Tread
1-1/16" x 13" x 48, 54, 60, 72, 84, 96"

RO-8070-18 x

Red Oak Tread
1-1/16" x 18" x 48, 54, 60, 72, 84"

RO-8070-20 x 60

Red Oak Tread
1-1/16" x 20" x 60"

RO-8070-20 x 72

Red Oak Tread
1-1/16" x 20" x 72"

RO-8070-24 x

Red Oak Tread
1-1/16" x 24" x 60", 72", 84", 96", 120"

RO-8070-48 x 48

Red Oak Tread
1-1/16" x 48" x 48"

RO-8070-60 x 60

Red Oak Tread
1-1/16" x 60" x 60"

RO-8070-48-MR

1-1/16" x 11-1/2" x 48"

RO-8070-54-MR

1-1/16" x 11-1/2" x 54"

RO-8070-60-MR

1-1/16" x 11-1/2" x 60"

Mitered Return (MR) (Reversible)

Overall length does not include mitered return



BULL NOSED LANDING TREAD

8090-6

RED OAK

8090-6B

RED OAK BENDING (26 pieces)



TONGUE & GROOVED BULL NOSED LANDING TREAD

8090-6-G

RED OAK (grooved)



TONGUE & GROOVED LUMBER

8095-8-T&G

RED OAK (tongue & grooved)

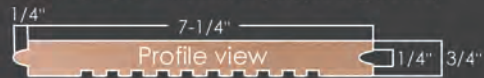

8095-12-T&G

RED OAK (tongue & grooved)

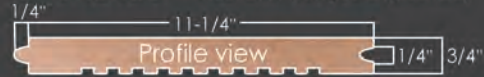

1" BULL NOSING

8080

RED OAK

8080-B

RED OAK BENDING
(5 pieces)



REMODEL TREAD WITH RISER KIT

TREAD

Red Oak Bull Nose Tread with Cove
1 1/16" x 10-1/2" x 42, 54, 60"

RISER

Red Oak Riser
5/8" x 7-1/2" x 42, 54, 60"

RETRO-42

RETRO-54

RETRO-60



REMODEL RETURN TREAD WITH RISER KIT

TREAD

Red Oak Bull Nose Tread with Cove
1 1/16" x 10-1/2" x 48, 54, 60"

RISER

Red Oak Riser
5/8" x 7-1/2" x 48, 54, 60"

RETRO-48MR

RETRO-54MR

RETRO-60MR



Reversible riser material for stain or paint.



No mitered return



Mitered return on
left and right



Mitered return on right



Mitered return on left

MODERN REMODEL TREAD & RISER KITS

- Get the look of thick block style treads at a fraction of the price!
- Replace old carpeted stairs
- Can be used on new construction

REMODEL TREAD WITH RISER KIT

TREAD 2-1/8" Red Oak Tread w/roundover
11/16" x 10-1/2" x 42, 54, 60"

RISER Red Oak Riser
5/8" x 7-1/2" x 42, 54, 60"



Reversible riser material for stain or paint.



MODERN-RETRO-42
MODERN-RETRO-54
MODERN-RETRO-60

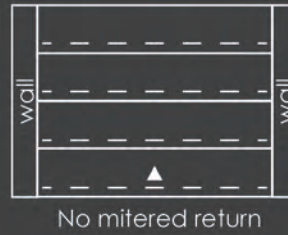

**2-1/8" THICK
RED OAK**

REMODEL RETURN TREAD WITH RISER KIT

TREAD 2-1/8" Red Oak Tread w/roundover
Mitered return on both ends
11/16" x 10-1/2" x 48, 54, 60"

RISER Red Oak Riser
5/8" x 7-1/2" x 48, 54, 60"

2-1/8"



MODERN-RETRO-48MR
MODERN-RETRO-54MR
MODERN-RETRO-60MR

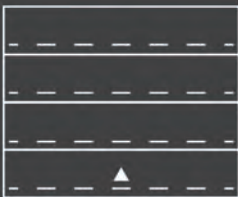

Mitered return on left and right



Mitered return on right



Mitered return on left

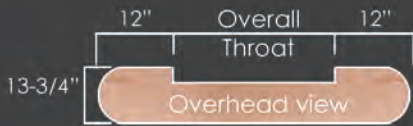

DOUBLE END STARTING STEP

Diameter: 13-3/4"
8015-48 (48" throat) (72" overall)
8015-54 (54" throat) (78" overall)
8015-60 (60" throat) (84" overall)
 Red Oak(RO)

Comes with:
 1" Thick Tread,
 6-3/4" Tall Riser
 Cove & Quarter Round Moulding

STARTER STEP VENEER

Width: 8"
 Length: 120"
RO-VENEER (Red Oak)

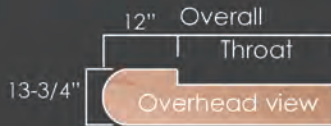

SINGLE END STARTING STEP

Diameter: 13-3/4"
8010-48 (48" throat) (60" overall)
8010-60 (60" throat) (72" overall)
8010-72 (72" throat) (84" overall)
 Red Oak(RO)

Comes with:
 1" Thick Tread,
 6-3/4" Tall Riser
 Cove & Quarter Round Moulding



SPECIAL WEDGE SHAPED DOUBLE END STARTING STEP

Diameter: 12-3/4" (small end)
 Diameter: 18-1/2" (large end)
RO-8915-48 (48" throat) (73-1/2" overall)
RO-8915-54 (54" throat) (79-1/2" overall)
 (Reversible)
 Red Oak(RO)

Comes with:
 1" Thick Tread,
 6-3/4" Tall Riser
 Cove & Quarter Round Moulding

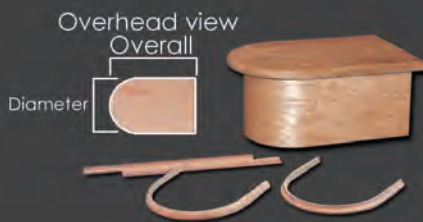
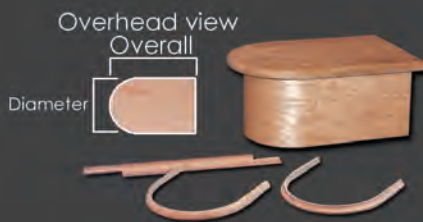

FALSE END STARTING STEP

Diameter: 13-3/4" Diameter: 17-1/2"
 Length: 17-5/8" overall Length: 21-3/4" overall
8011 **8012**
 Red Oak(RO)

Comes with:
 1" Thick Tread,
 6-3/4" Tall Riser
 Cove & Quarter Round Moulding

PLYWOOD

PLY-1/4-MDF	MDF 1/4" x 4' x 8'	Half Sheet 1/4" x 2' x 8'
PLY-3/4-MDF	MDF 3/4" x 4' x 8'	
PLY-1/8-RO	Red Oak 1/8" x 4' x 8'	Half Sheet 1/4" x 2' x 8'
PLY-1/4-RO	Red Oak 1/4" x 4' x 8'	Half Sheet 1/4" x 2' x 8'
PLY-1/2-RO	Red Oak 1/2" x 4' x 8'	
PLY-3/4-RO	Red Oak 3/4" x 4' x 8'	
PLY-1/8-Birch	Birch 1/8" x 4' x 8'	
PLY-1/4-Birch	Birch 1/4" x 4' x 8'	Half Sheet 1/4" x 2' x 8'
PLY-1/2-Birch	Birch 1/2" x 4' x 8'	
PLY-3/4-Birch	Birch 3/4" x 4' x 8'	
PLY-3/8-Bending	Red Oak 3/8" x 4' x 8'	(bending board)

LUMBER

RO-06	Red Oak 3/4" x 5-1/2" S4S Lumber
RO-08	Red Oak 3/4" x 7-1/4" S4S Lumber
RO-08-B	Red Oak 3/4" x 7-1/4" Bending (29 pieces)
RO-12	Red Oak 3/4" x 11-1/4" S4S Lumber
MDF-06	MDF 11/16" x 5-1/4"
MDF-08	MDF 11/16" x 7-1/4"
MDF-12	MDF 11/16" x 11-1/4"

WOOD MOULDING & FLEXIBLE TRIM



RO-C8	Red Oak 2-1/2" x 11/16" Colonial Casing
PG-C8	Paint Grade 2-1/2" x 11/16" Colonial Casing
FLEX-C8	Paint Grade 2-1/2" x 11/16" Colonial Casing



PG-CAP MOULD	Paint Grade 1-1/8" x 3/8" Cap Mould
---------------------	-------------------------------------



RO-6007	Red Oak 1-3/4" Filet
PG-6007	Paint Grade 1-3/4" Filet



RO-6050	Red Oak 1-1/4" Filet
PG-6050	Paint Grade 1-1/4" Filet



RO-PM-1	Red Oak 11/16" x 1/-1/4" RAB. Panel Mould
PG-PM-1	Paint Grade 11/16" x 1/-1/4" RAB. Panel Mould
Flex-PM-1	Flexible Smooth 11/16" x 1/-1/4" RAB. Panel Mould
Flex-PM-1-WG	Flexible Wood Grain 11/16" x 1/-1/4" RAB. Panel Mould (1/4" Offset)



RO-PM-2	Red Oak 11/16" x 1/-1/4" RAB. Panel Mould
PG-PM-2	Paint Grade 11/16" x 1/-1/4" RAB. Panel Mould
Flex-PM-2	Flexible Smooth 11/16" x 1/-1/4" RAB. Panel Mould
Flex-PM-2-WG	Flexible Wood Grain 11/16" x 1/-1/4" RAB. Panel Mould (3/4" Offset)



RO-PM-5	Red Oak 11/16" x 1-1/8" Flat Panel Mould
PG-PM-5	Paint Grade 11/16" x 1-1/8" Flat Panel Mould
Flex-PM-5	Flexible Smooth 11/16" x 1-1/8" Flat Panel Mould
Flex-PM-5-WG	Flexible Wood Grain 11/16" x 1-1/8" Flat Panel Mould



RO-8050	Red Oak 7/16" x 3/4" Base Shoe Mould
Flex-MS-127	Flexible Smooth 7/16" x 3/4" Base Shoe Mould
Flex-MS-127-WG	Flexible Wood Grain 7/16" x 3/4" Base Shoe Mould



RO-8060	Red Oak 3/4" x 3/4" Cove Mould
PG-8060	Paint Grade 3/4" x 3/4" Cove Mould



RO-8065	Red Oak 1/2" x 1/2" Cove Mould
PG-8065	Paint Grade 1/2" x 1/2" Cove Mould
Flex-MS-101	Flexible Smooth 1/2" x 1/2" Cove Mould
Flex-MS-101-WG	Flexible Wood Grain 1/2" x 1/2" Cove Mould

ACCESSORIES

WALL RAIL BRACKET

1-1/4" x 2-3/8" Mounting Plate
3" Extension From Wall



- HFBC.3002 (BRUSHED CHROME)
- HFCV.3002 (COPPER VEIN)
- HFORB.3002 (OIL RUBBED BRONZE)
- HFORC.3002 (OIL RUBBED COPPER)
- HFPB.3002 (POLISHED BRASS)
- HFSC.3002 (SATIN CLEAR)
- HFSP.3002 (SILVER VEIN)
- HFAG.3002 (ASH GREY)
- HFSTB.3002 (SATIN BLACK)

HANDRAIL BRACKET

2-1/16" Rd. Mounting Plate
3" Extension From Wall



- HFBC.3003 (BRUSHED CHROME)
- HFGD.3003 (DORADO GOLD)
- HFCE.3003 (CHROME)
- HFNL.3003 (NICKEL)
- HFCV.3003 (COPPER VEIN)
- HFORB.3003 (OIL RUBBED BRONZE)
- HFORC.3003 (OIL RUBBED COPPER)
- HFPB.3003 (POLISHED BRASS)
- HFSC.3003 (SATIN CLEAR)
- HFSP.3003 (SILVER VEIN)
- HFAG.3003 (ASH GREY)
- HFSTB.3003 (SATIN BLACK)

NEWEL MOUNT HANDRAIL BRACKET



HT. 1-3/4"
Base = 1-1/2" sq.
ADJUSTABLE



- HF17.4001
Stainless Steel(304)
- HFSTB17.4001
Satin Black

HANDRAIL BRACKET



HT. 2-1/2"
Base = 1-1/2" x 2"
Extends 3-1/4" off wall
ADJUSTABLE



- HF17.4002
Stainless Steel(304)
- HFSTB17.4002
Satin Black

mounting hardware included

WOOD GLUE & FILLER



- S-9202 (1 Gal.)
Titebond Original Wood Glue
- S-9203 (32 oz.)
Titebond Original Wood Glue
- S-9204 (16 oz.)
Titebond Original Wood Glue
- S-9205 (8 oz.)
Titebond Original Wood Glue
- FAM-O-WOOD S-9200
RO-9208 (Red Oak)

EPOXY GUN-EPC-101



EPOXY-EPC-410



EPOXY PASTE EPC-7



OAK ROSETTES



- RO-7033 4"x 5-1/2" (Red Oak)
- RO-7037 4"x 5-1/2" (Red Oak)
- RO-7039 4"x 4" (Red Oak)

OAK PLUGS

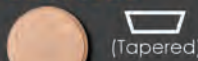

- RO-9001 (3/8")
- RO-9002 (1/2")
- RO-9003 (5/8")
- RO-9004 (3/4")
- RO-9005 (1")
- RO-9006 (1-1/4")
- RO-9007 (1-1/2")

NEWEL FASTENER S-9403



Sure Tite

NEWEL FASTENER S-9401



Key Lock

RAIL BOLT KIT S-9600

(Includes hex nut, spacer and 1" Red Oak plug)



RAIL BOLT DRIVER S-9600-D

(fits machine thread)



sold individually

DOWEL SCREW C-905-2

(25 per bag)



DRIVER C-905-2D

(fits wood screw thread)



sold individually

AXIA®

STAIR & RAILING SYSTEMS



STYLE



QUALITY



VALUE

We offer the most in-demand, high quality stainless steel stair & railing systems at the lowest price possible. From day one, we set out to do things a little bit different. Our goal has always been to provide stainless systems that are ideal for the residential stair installer/builder while also surpassing the expectations of the most discerning homeowners.

Sales Displays & Product Samples

Our wide variety of sales displays will provide you with the tools to sell products. We have sizes to fit your floor space. Custom displays are also available.



Axia Post Systems - Floor Display
Dimensions: 56" W x 8" D x 44" H



Axia Post Systems - Table Top Display
Dimensions: 30" W x 8" D x 24" H

Estimation Services

We offer full estimation services based on your plans. We can also offer quick-quoting based on the designs featured in our design guide.



Product Catalog

Full line product catalog featuring:
 Post Railing Systems
 Round Series
 Square Series
 Glass Railing Systems
 Standoff Series
 U-Channel Series
 Installation Accessories

Design Guide

Features over thirty pre-configured stair and balcony designs for inspiration and quick quoting. This guide is a valuable sales tool and visual guide to navigate our systems.

Installation Guides

Get pro level instruction on the best way to install our systems. Loaded with tips and tricks for best results these guides cover all the basics of installation and tools/accessories.



MARKETING TOOLS

House of Forgings Modular Floor Display

Quick Installation:
Fully assembled in under 15 minutes!
Tools required: Phillips screwdriver

Retail Displays Increase Sales

MODULAR DISPLAY: Our Modular Display is available as a free standing unit containing six removable panels.

DISPLAY PANELS: If floor space is an issue, we have you covered. All of our Display Panels can be ordered individually and come with wall hangers and product brochure holders pre installed.

ORDERING: To order a Modular Display or specific Display Panels, please contact your sales representative at (866) 443-4848



Display Dimensions:
30" W x 30" D x 72" H

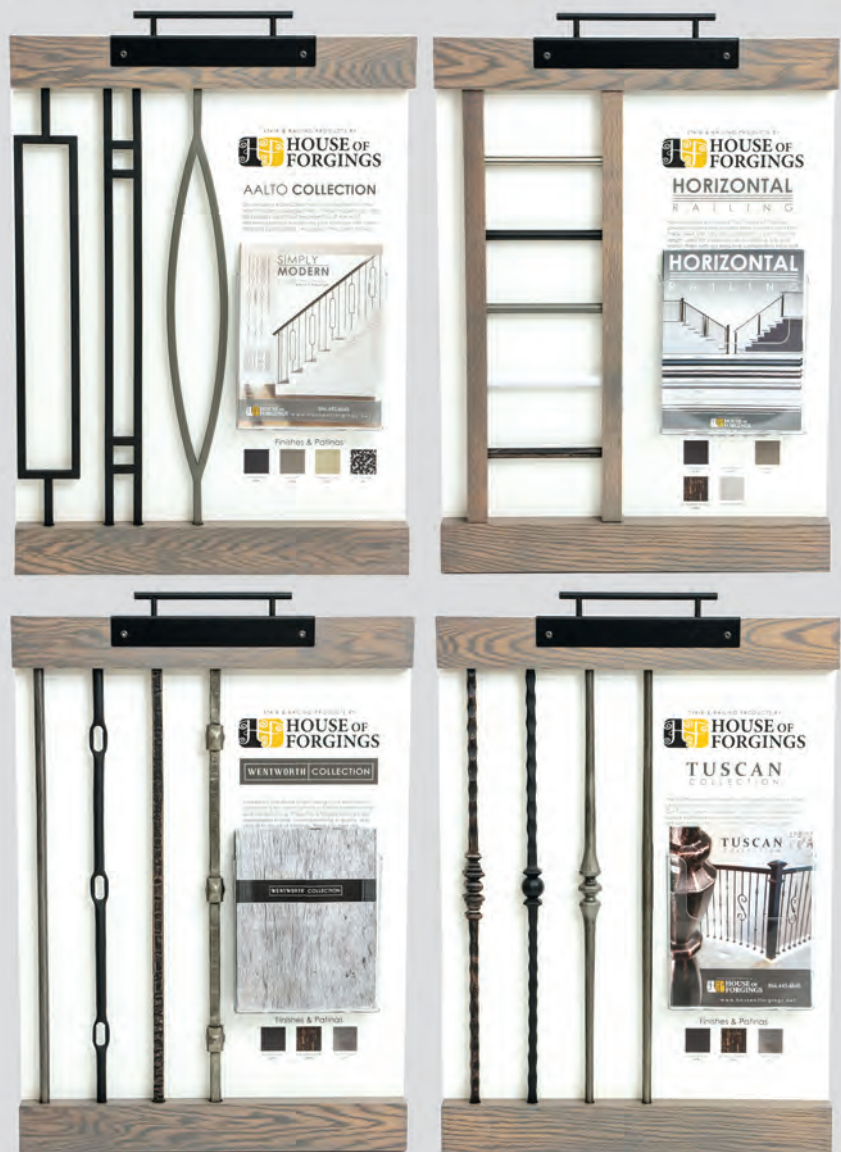

Panel Dimensions: 24" W x 2" D x 30" H

Panels available for:

Soho Balustrade - Foundation Balusters - Horizontal Bar Railing
Wentworth Collection - Aalto Collection - Tuscan Collection

MARKETING TOOLS

House of Forgings Sales & Marketing Support

Sales Displays & Product Samples

Our wide variety of sales displays will provide you with the tools to sell products. We have sizes to fit your floor space. Custom displays are also available.



Powder Coated Finishes
Sample Chips



Powder Coated Finishes
Sample Balusters - 8" Length



Horizontal Bar Railing
Table Top Display
Dimensions: 24" W x 8" D x 18" H



Axia Post Systems
Table Top Display
Dimensions: 30" W x 8" D x 24" H



Carousel Floor Display
Dimensions:
18" W x 18" D x 48" H

Software & Design

Web based Stair Artist stair design tool makes it easy to plan your staircase project. Our extensive library of CAD images and product photos will aid and inspire you in designing your staircase.



Marketing Literature

We offer a wide array of marketing literature designed to support product sales: product catalogs, brochures, flyers, postcards and customized literature are available through our authorized dealer program.

Inquire with your sales representative about product catalogs and additional product support.

CUSTOMIZATION OPTIONS

Iron Fabrication, Finishing and More

Transform Existing Products Into New Creations

We manage your fabrication project from start to finish, offering design services, estimation, project management and quality assurance. We take the hassle out of your project, leaving you more time and resources to focus on satisfying your customers with impeccable end results.

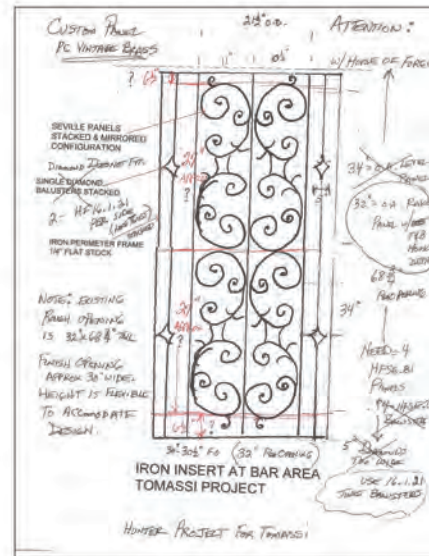

Step 1 - EXPLORE

Find existing House of Forgings parts that inspire your vision.

Step 2 - CONCEPT

Share your ideas and specifications for modifying an existing part.

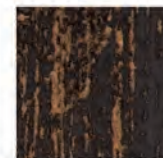
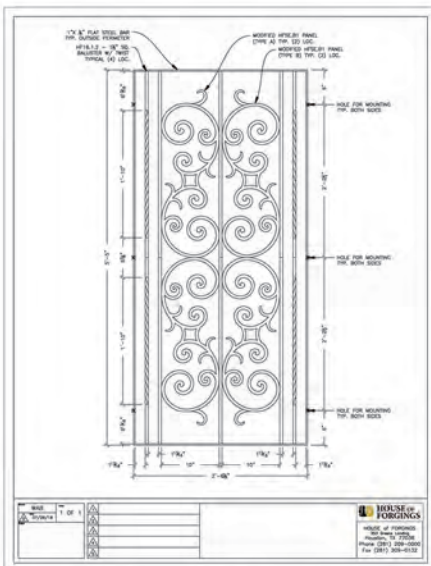

Oil Rubbed Bronze Finish hand applied over Satin Black powdercoat

Step 3 - DESIGN

We help take your rough concepts and turn them into professional designs for your final approval.

Step 4 - FINISHED PRODUCT

Once approved, your custom product is produced (raw or powder coated) and shipped within 2-6 weeks.

EURO FORGE

Access to Our World Class Manufacturing

ITALY·USA

DESIGN COLLABORATIVE

You Design It. We Bring It to Life!

Together with our Italian factory we bring your vision to reality. Whether you have a simple inspiration photo or detailed drawings of a single element or entire staircase we specialize in a full range of manufacturing options ideally suited to exceed your expectations.

Forging - Casting - Stamping - Bending - Rolling - Laser Cutting

Stair Parts - Decorative Panels - Window Coverings - Furniture Components - & More

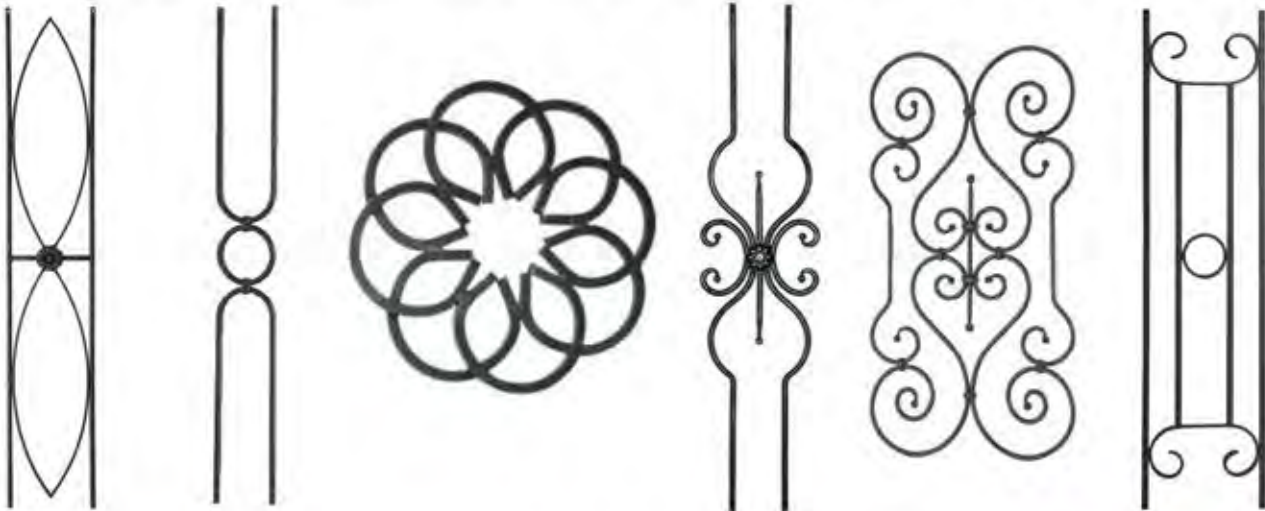

THERMA-CUT LASER CUTTING

Your drawings take shape with fully custom laser cutting for interior or exterior applications.

Sheet metal is thermally cut with high accuracy to create and transform ordinary sheet metal into decorative outdoor fencing, gates, interior panels, shelves, partitions, iron tapestries, and more.

TYPE OF MATERIAL	THICKNESS	MAXIMUM SIZE
Raw Metal (black or pickled)	20ga to 3/4"	6'6" x 13'
Pre-Galvanized	20ga to 6ga	4'11" x 13'
Corten	16ga to 3/8"	4'11" x 9'10"
Stainless 304/316	20ga to 9/16"	6'6" x 13'



Inquire for more information

STAIR & RAILING PRODUCTS BY

