

HOUSE OF FORGINGS

STAIR & RAILING PRODUCTS

STAIR & RAILING PRODUCTS BY



**HOUSE OF FORGINGS**  
*Reviving the Splendor of Wrought Iron*

## Powder Coated & Stainless Steel

**House of Forgings  
is the benchmark in  
the stair and railing  
industry, offering an  
unsurpassed  
selection of quality  
products and  
expert service.**

Our vast selection of products will meet the needs of even the most discerning customers. Whether selecting a powder coated finish or stainless steel, our newels, balusters and accessories will compliment a broad range of architectural styles.

STAIR & RAILING PRODUCTS BY



**HOUSE OF  
FORGINGS**  
*Reviving the Splendor of Wrought Iron*

# Table of Contents

POWDER COATED & STAINLESS STEEL	2-47
Finishes & Patinas	2-3
Tuscan	4-9
Nouveau	10-11
Orleans	12-13
Monte Carlo	16-17
Endecor	14-15
Designer	18-19
Stainless	20-21
Santa Fe	22-23
Gothic	24-25
Round	26-29
Scroll	30-33
Versatile	34-37
Ribbon	38-41
Twist	42-45
Accessories	46-47
FORGED PANELS	48-71
Rebecca	50-51
Tuscany	52-54
Seville	56-57
Milano	58-61
Bordeaux	62-65
Regency	66-69
Michelle	70-71
WOOD	72-87
Newels & Balusters	74-77
Elegante & Box Newels	78-81
Handrail & Fittings	82-83
Treads	84
Starter Steps	84
Lumber & Plywood	84
Moulding	86
Accessories	87
COMPANY & PRODUCT INFORMATION	88



**RAW IRON (RAW)**

*This is raw (unfinished) iron that needs to be painted or powder coated.*



**SATIN BLACK (STB)**



**ASH GREY (AG)**



**SILVER VEIN (SP)**



**COPPER VEIN (CV)**



**OIL RUBBED BRONZE (ORB)**



OIL RUBBED COPPER (ORC)



ANTIQUÉ NICKEL (AN)



VINTAGE BRASS (VB)



SATIN CLEAR (SC)

*This is a clear finish over RAW/unfinished iron, variations in surface color may occur.*



STAINLESS STEEL

## Finishes & Patinas

House of Forgings provides an unsurpassed selection of designs in the highest quality powdercoated finishes available. Our hand applied patinas enhance the lines and hammered detail of each unique piece. As interior design trends move forward, count on us to carry the latest styles & finishes.

THESE FINISHES HAVE BEEN PROFESSIONALLY PHOTOGRAPHED WITH THE HIGHEST INTEGRITY. OUR GOAL IS TO PRODUCE THE MOST REALISTIC MATCH TO THE ACTUAL FINISHES, HOWEVER SOME SLIGHT VARIANCES MAY OCCUR.

All images are the sole property of House of Forgings, LLC. and cannot be copied or reproduced without written permission.



Oil Rubbed Bronze (shown)

The craftsmanship in these hand-forged balusters exude character and beauty nearly impossible to duplicate. Our Tuscan series is available in both round forged and square hammered profiles. Bring the rustic charm of old world Italy into your home with this unique series.

Oil Rubbed Bronze (shown)

# TUSCAN



Vintage Brass (shown)



Oil Rubbed Bronze (shown)

# TUSCAN

ROUND FORGED



## Finishes & Patinas

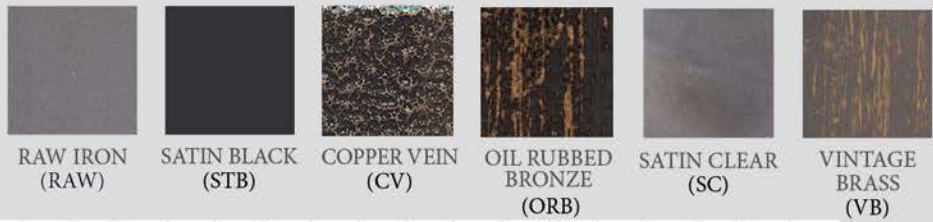

	NEWELS	HF1.1.8	HF1.1.9	HF1.1.16	HF1.1.20	HF1.1.21	BALUSTERS	HF2.9.21	HF2.1.5	HF2.1.6	HF2.1.7	HF2.1.9	HF2.1.8	HF2.1.11	HF2.6.8	HF2.6.9	HF2.6.7	HF2.10.2	HF2.10.4	HF2.10.3	HF2.11.40	HF2.11.41	
RAW		•	•	•	•	•		•	•	•	•	•	•	•	•	•	•	•	•	•	•	•	•
STB		•	•	•	•	•		•	•	•	•	•	•	•	•	•	•	•	•	•	•	•	•
CV				•				•										•	•	•			
ORB		•	•	•	•	•		•	•	•	•	•	•	•	•	•	•	•	•	•	•	•	•
SC				•		•		•							•	•	•	•	•	•			
VB				•	•	•		•							•	•	•	•	•	•	•	•	•

### ACCESSORIES

- Level base shoes
- Level base collars
- Angled base shoes
- Adjustable level base shoes
- Adjustable angled base shoes
- Newel mounting kit

- HF16.3.26
- HF16.3.40, HF16.3.43
- HF16.3.27
- HF16.3.44, HF16.3.46
- HF16.3.45, HF16.3.47
- HF16.3.33

- Photos: J.
- Photos: K. O.
- Photos: N.
- Photos: R.
- Photos: S.
- Photos: U.

For photos and full accessory details see pages 46-47



**NEWEL** 15" 5" 27"

**HF 1.1.8**  
Ends : 1" Rd.  
Height: 47"  
Wt. 18 lbs.

**NEWEL** 17" 3" 27"

**HF 1.1.9**  
Ends : 1" Rd.  
Height: 47"  
Wt. 18 lbs.

**NEWEL** 15" 5" 27"

**HF 1.1.16**  
Ends : 1" Rd.  
Height: 47"  
Wt. 18 lbs.

**NEWEL** 14-13/16" 8-14/16" 24-3/16"

**HF 1.1.20**  
Ends : 1" Rd.  
Height: 47"  
Wt. 18 lbs.

**NEWEL** 16" 2-3/4" 28-1/2"

**HF 1.1.21**  
Ends : 1" Rd.  
Tapered  
Height: 47"  
Wt. 18 lbs.

**NEWEL** 17-1/2" 4-1/2" 22"

**HF 2.1.5**  
Ends : 9/16" Rd.  
Height: 44"  
Wt. 2.5 lbs.

**NEWEL** 5" 12-1/2" 14-1/2" 17"

**HF 2.1.6**  
Ends : 9/16" Rd.  
Height: 44"  
Wt. 4.2 lbs.

**NEWEL** 9" 4-1/2" 11" 4-1/2" 15"

**HF 2.1.7**  
Ends : 9/16" Rd.  
Height: 44"  
Wt. 3 lbs.





**HF 2.1.9**  
 Ends : 9/16" Rd.  
 Height: 44"  
 Wt. 2.4 lbs.



**HF 2.1.8**  
 Ends : 9/16" Rd.  
 Height: 44"  
 Wt. 4.2 lbs.



**HF 2.1.11**  
 Ends : 9/16" Rd.  
 Height: 44"  
 Wt. 3 lbs.



**HF 2.6.8**  
 Ends : 9/16" Rd.  
 Tapered  
 Height: 44"  
 Wt. 3.2 lbs.



**HF 2.6.9**  
 Ends : 9/16" Rd.  
 Height: 44"  
 Wt. 4.2 lbs.



**HF 2.6.7**  
 Ends : 9/16" Rd.  
 Tapered  
 Height: 44"  
 Wt. 3.8 lbs.



**HF 2.9.21**  
 Ends : 9/16" Rd.  
 Height: 44"  
 Wt. 2.4 lbs.



**HF 2.10.2**  
 Ends : 9/16" Rd.  
 Height: 44"  
 Wt. 3.2 lbs.



**HF 2.10.4**  
 Ends : 9/16" Rd.  
 Height: 44"  
 Wt. 4.2 lbs.



**HF 2.10.3**  
 Ends : 9/16" Rd.  
 Height: 44"  
 Wt. 3.6 lbs.



**HF 2.11.40**  
 Ends : 9/16" Rd.  
 Height: 44"  
 Wt. 4 lbs.



**HF 2.11.41**  
 Ends : 9/16" Rd.  
 Height: 44"  
 Wt. 5.2 lbs.

# TUSCAN

SQUARE HAMMERED



## Finishes & Patinas



	NEWELS	HF1.1.10	HF1.1.11	HF1.1.14	HF1.1.15	BALUSTERS	HF2.9.12	HF2.9.11	HF2.9.13	HF2.9.3	HF2.9.4	HF2.9.8	HF2.9.5	HF2.9.6	HF2.1.2	HF2.1.1	HF2.9.20	HF2.9.28	HF2.9.27	HF2.9.26	HF2.9.29	HF2.9.36	HF2.9.37
RAW		•	•	•	•		•	•	•	•	•	•	•	•			•	•	•	•			
STB		•	•	•	•		•	•	•	•	•	•	•	•			•	•	•	•	•	•	•
CV			•	•	•		•	•	•			•					•	•	•	•			
ORB		•	•	•	•		•	•	•	•	•	•	•	•			•	•	•	•	•	•	•
SC			•	•	•		•	•	•			•					•	•	•	•	•	•	•
VB			•	•	•		•	•	•			•					•	•	•	•	•	•	•

### ACCESSORIES

- Level base shoes
- Level base collars
- Angled base shoes
- Adjustable level base shoes
- Adjustable angled base shoes
- Newel mounting kit

- HF16.3.25
- HF16.3.41, HF16.3.42
- HF16.3.28
- HF16.3.44, HF16.3.46
- HF16.3.45, HF16.3.47
- HF16.3.31

- Photos: C.
- Photos: D. H.
- Photos: G.
- Photos: R.
- Photos: S.
- Photos: T.

For photos and full accessory details see pages 46-47



**NEWEL**

14-1/4"

6-3/4"

26"

**HF 1.1.10**  
Ends : 1" Sq.  
Tapered  
Height: 47"  
Wt. 18 lbs.

**NEWEL**

14"

7"

26"

**HF 1.1.11**  
Ends : 1" Sq.  
Tapered  
Height: 47"  
Wt. 18 lbs.

**NEWEL**

47"

**HF 1.1.14**  
Ends : 1" Sq.  
Height: 47"  
Wt. 18 lbs.

**NEWEL**

15-1/2"

4-1/2"

27"

**HF 1.1.15**  
Ends : 1" Sq.  
Height: 47"  
Wt. 18 lbs.

17-1/2"

4-1/2"

22"

**HF 2.9.12**  
Ends : 9/16" Sq.  
Tapered  
Height: 44"  
Wt. 3.8 lbs.

5"

12-1/2"

14-1/2"

17"

**HF 2.9.11**  
Ends : 9/16" Sq.  
Height: 44"  
Wt. 5 lbs.

10"

4-1/2"

10-1/2"

4-1/2"

14-1/2"

**HF 2.9.13**  
Ends : 9/16" Sq.  
Tapered  
Height: 44"  
Wt. 5.5 lbs.

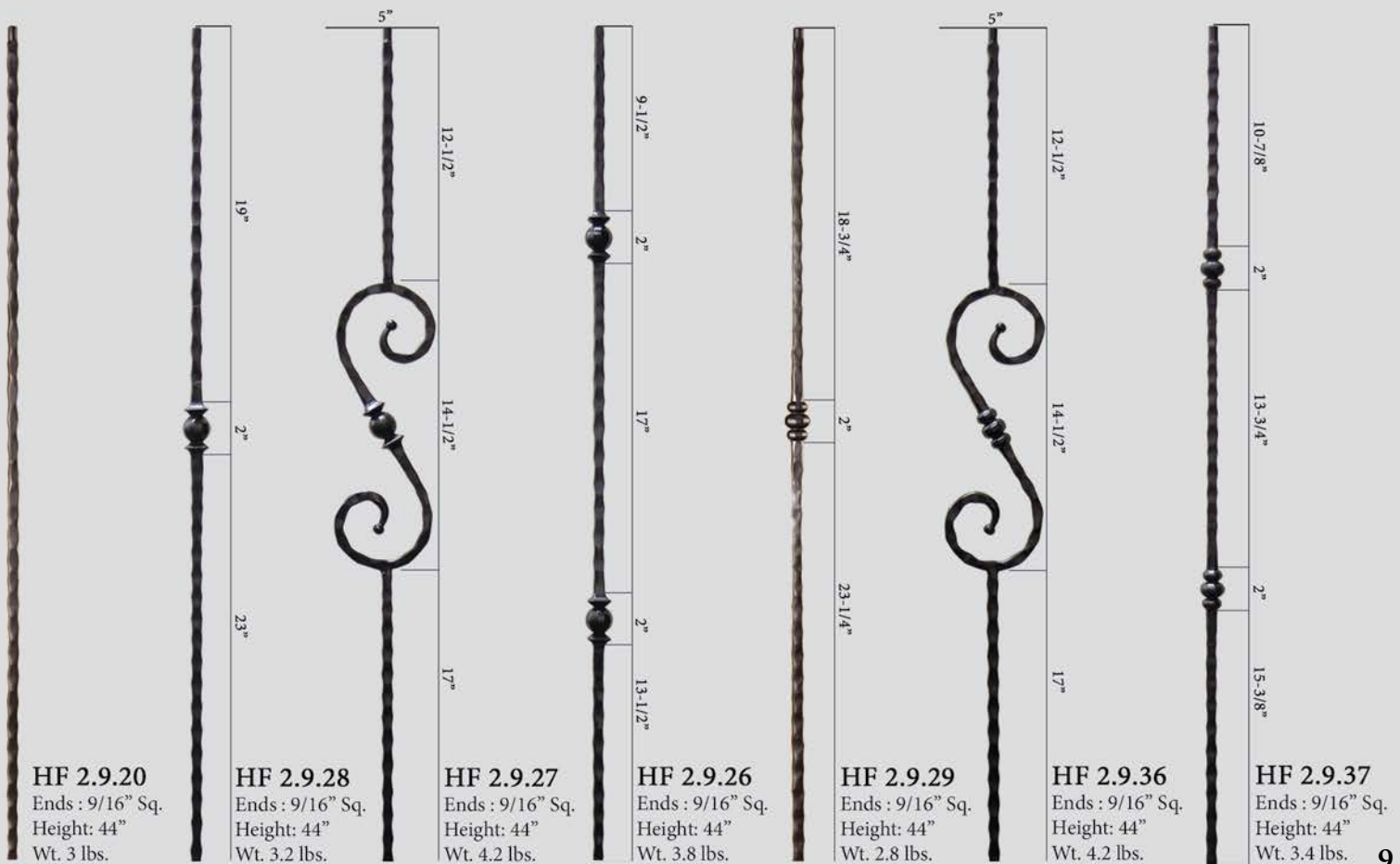
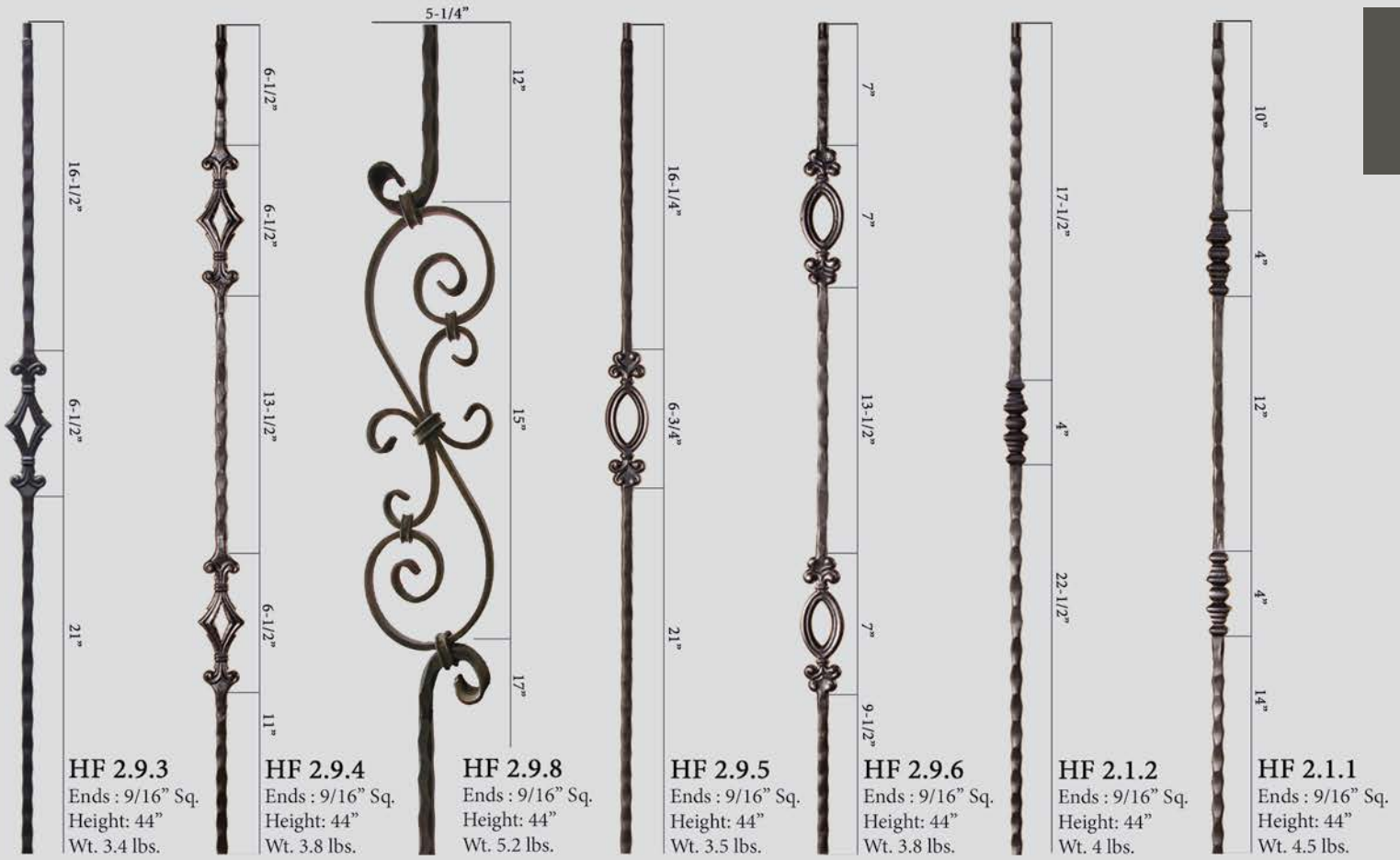

# NOUVEAU



Satin Black (shown)

Designed to compliment our Tuscan series, our Nouveau hand forged panels will elevate the decor of any home to new heights. Achieve the look of an expensive custom fabricated stair or balcony with these easy to install profiles.

*Nouveau*  
Hand Forged Panels



Satin Black (shown)

# NOUVEAU

SQUARE HAMMERED

ROUND FORGED



## Finishes & Patinas



RAW IRON  
(RAW)



SATIN BLACK  
(STB)



OIL RUBBED  
BRONZE  
(ORB)



VINTAGE  
BRASS  
(VB)



**HF9.2.23 (level)**  
Ends : 9/16" Square  
Height: 44"  
Wt. 17.95 lbs.



**HF9.2.24 (rake)**  
Ends : 9/16" Square.  
Height: 44"  
Wt. 15.9 lbs.



**HF9.2.21 (level)**  
Ends : 9/16" Round  
Height: 44"  
Wt. 15 lbs.



**HF9.2.22 (rake)**  
Ends : 9/16" Round  
Height: 44"  
Wt. 13.05 lbs.

*"The Nouveau panels' moderate width makes them a great option for all staircases.  
The rake specific panels should be cut from the top to fit handrail height before installation"*

# ORLEANS



Oil Rubbed Bronze (shown)

House of Forgings is pleased to feature our Orleans Series balusters which is a tribute to the renowned culture, customs and architecture of the great city of New Orleans. These exclusive designs are available with single or double elements and finished in Oil Rubbed Bronze and Vintage Brass patinas.

*Orleans*



Vintage Brass (shown)

Oil Rubbed Bronze (shown)

# ORLEANS

SQUARE HAMMERED



## Finishes & Patinas



RAW IRON  
(RAW)



OIL RUBBED  
BRONZE  
(ORB)



VINTAGE  
BRASS  
(VB)



**HF 1.1.14**  
Ends : 1" Sq.  
Height: 47"  
Wt. 18 lbs.



**HF 2.9.20**  
Ends : 9/16" Sq.  
Height: 44"  
Wt. 3 lbs.



**HF 2.9.23**  
Ends : 9/16" Sq.  
Height: 44"  
Wt. 3.5 lbs.



**HF 2.9.24**  
Ends : 9/16" Sq.  
Height: 44"  
Wt. 3.9 lbs.

### ACCESSORIES

Level base shoes

Level base collars

Angled base shoes

Adjustable level base shoes

Adjustable angled base shoes

Newel mounting kit

**HF16.3.25**

**HF16.3.41, HF16.3.42**

**HF16.3.28**

**HF16.3.44, HF16.3.46**

**HF16.3.45, HF16.3.47**

**HF16.3.31**

Photos: C.

Photos: D. H.

Photos: G.

Photos: R.

Photos: S.

Photos: T.

For photos and full accessory details see pages 46-47



# MONTE CARLO



Oil Rubbed Bronze (shown)

Drawing inspiration from the great Roman columns, the Monte Carlo series stands alone in style and elegance. The robust designs compliment the prominence of even the grandest estates. The intricately cast components are highlighted by the Oil Rubbed Bronze patina.

Oil Rubbed Bronze (shown)





# MONTE CARLO

ROUND



# Finishes & Patinas



SATIN BLACK  
(STB)



OIL RUBBED  
BRONZE  
(ORB)



NEWEL

**HF 18.1.1**  
Ends : 1-3/16" Rd.  
Height: 48"  
Wt. 25.5 lbs.



**HF 18.2.1**  
Ends : 5/8" Rd.  
Height: 44"  
Wt. 5 lbs.



**HF 18.2.2**  
Ends : 5/8" Rd.  
Height: 44"  
Wt. 4 lbs.

## ACCESSORIES

Level base shoes  
Angled base shoes  
Newel mounting kit

**HF16.3.35**  
**HF16.3.36**  
**HF16.3.14**

Photos: J.  
Photos: N.  
Photos: U.

For photos and full accessory details see pages 46-47



ENDECOR



Vintage Brass (shown)

A House of Forgings exclusive, the Endecor® balustrade system has been featured by some of the top homebuilders in the nation. For the discerning client who wants to stand apart, these balusters are truly unique in form and function.

US D672,064 S  
BALUSTER END PIECE



Satin Black (shown)



Additional U.S and Canadian patents pending.

# ENDECOR®

SQUARE



## Finishes & Patinas



SATIN BLACK  
(STB)



OIL RUBBED  
BRONZE  
(ORB)



VINTAGE  
BRASS  
(VB)

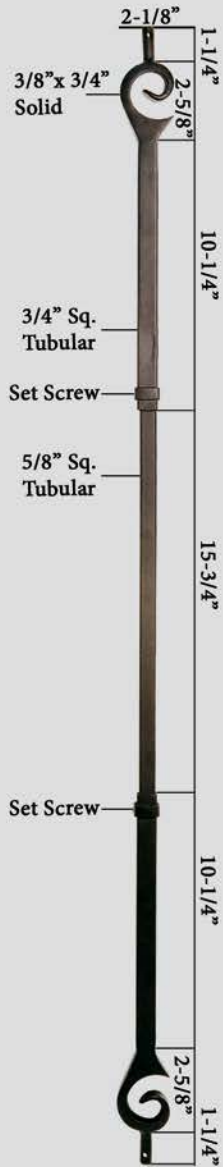

**HF16.7.1**  
Ends : 9/16" Rd.  
Height: 44"  
Wt. 3.8 lbs.

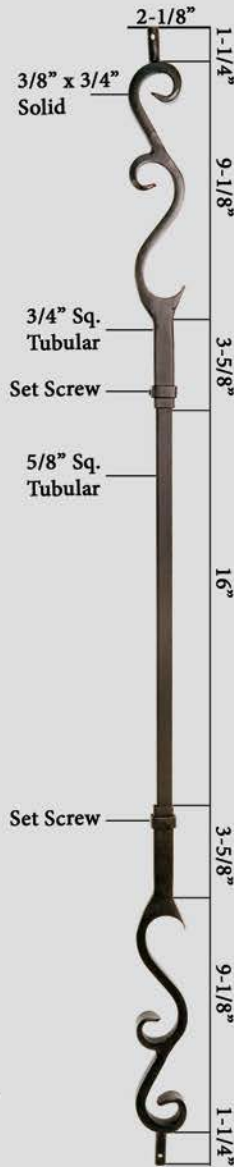

**HF16.7.2**  
Ends : 9/16" Rd.  
Height: 44"  
Wt. 3.8 lbs.

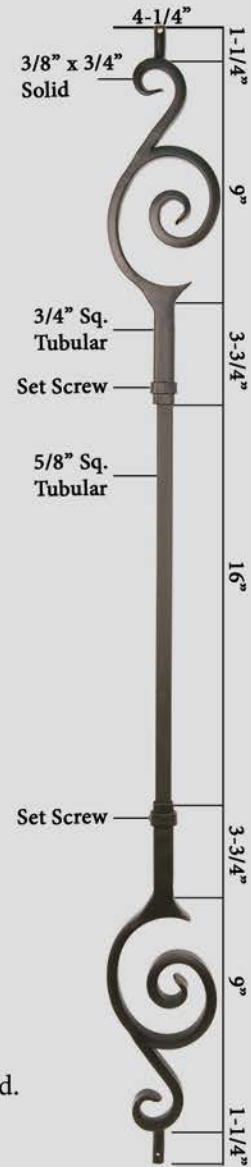

**HF16.7.3**  
Ends : 9/16" Rd.  
Height: 44"  
Wt. 3.8 lbs.

↑  
US D672,064 S  
BALUSTER END PIECE

# DESIGNER



Oil Rubbed Bronze (shown)

The designer series offers an upgraded look at an affordable price for homebuilders and homeowners alike. These hollow balusters are offered in square or round and compliment a wide range of architectural styles.

Oil Rubbed Bronze (shown)



Oil Rubbed Bronze (shown)

# DESIGNER TUBULAR

ROUND

SQUARE



## Finishes & Patinas



RAW IRON  
(RAW)



SATIN BLACK  
(STB)



OIL RUBBED  
BRONZE  
(ORB)

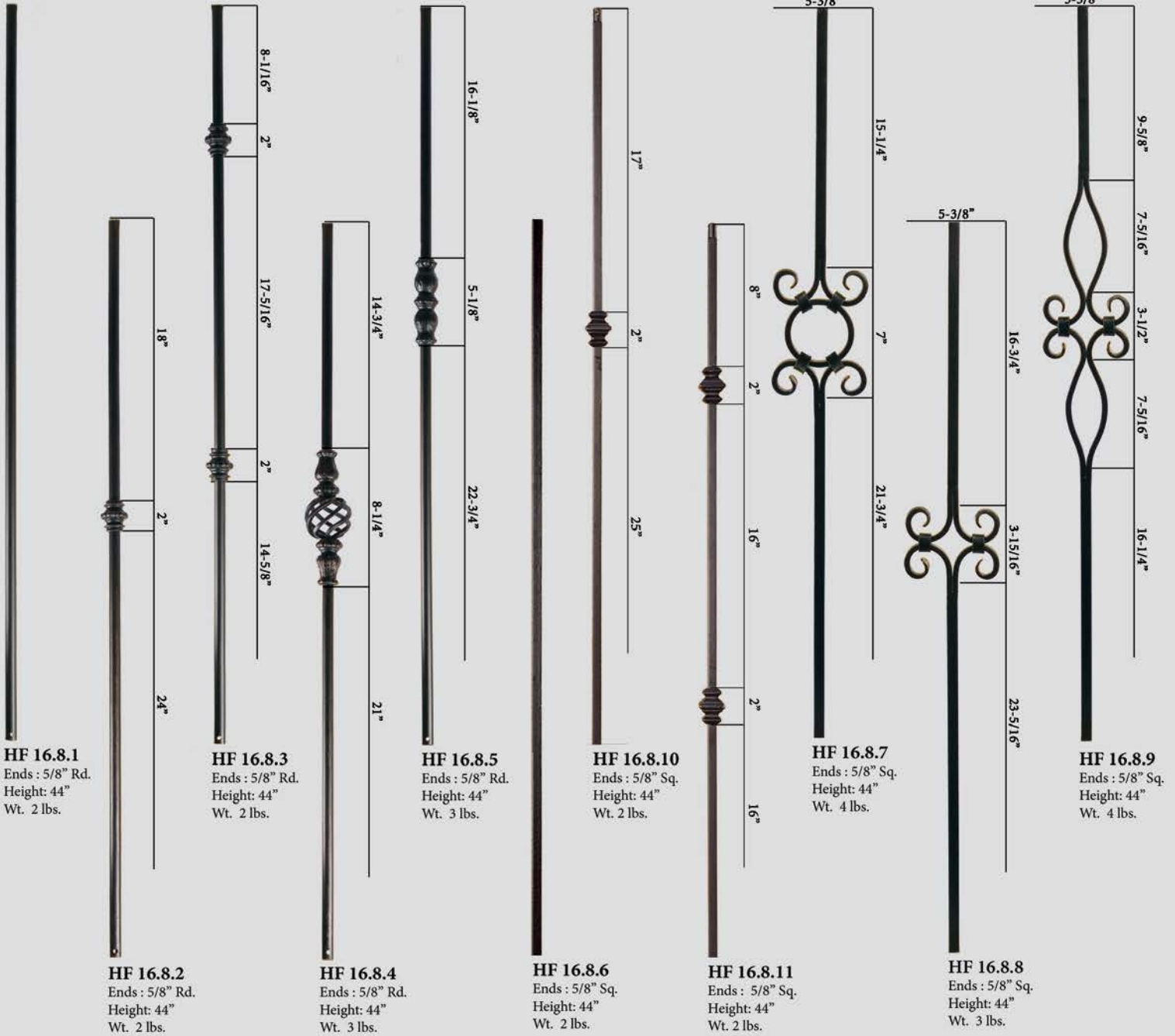

## ACCESSORIES

Level base shoes  
Angled base shoes

**HF16.3.35, HF16.3.38**  
**HF16.3.36, HF16.3.39**

Photos: J. C.  
Photos: N. G.

For photos and full accessory details see pages 46-47



# STAINLESS STEEL



Stainless steel is a mainstay in the modern and contemporary home decor market. The simple, honest lines of this profile is the perfect compliment to your urban dwelling. Now, offered in a more affordable tubular style for the budget savvy buyer.



# STAINLESS STEEL

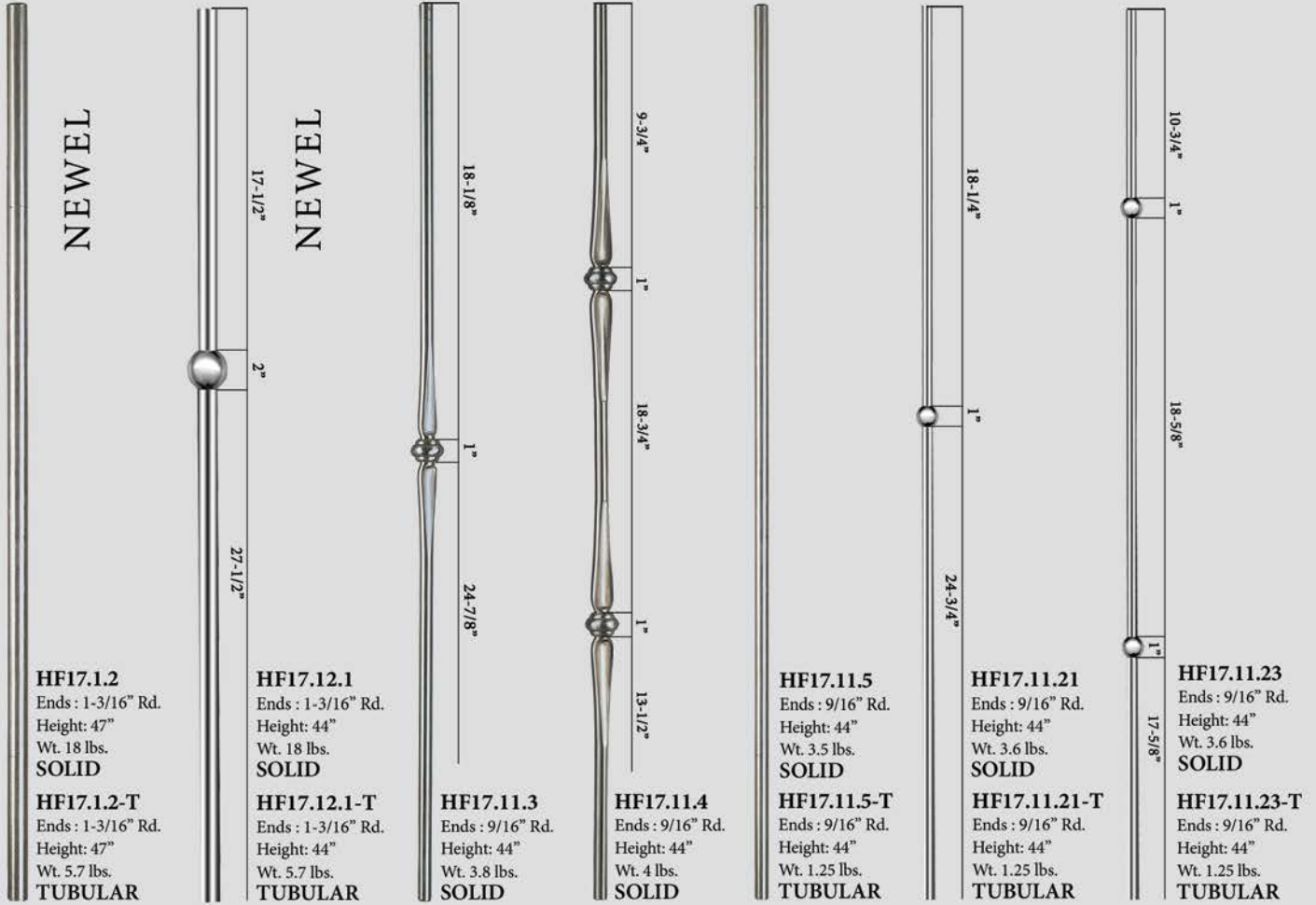

## ACCESSORIES

Level base collar  
Newel mounting kit

**HF17.11.22**  
**HF17.2.3**

Photos: L.  
Photos: V.

For photos and full accessory details see pages 46-47





## SANTA FE

Satin Black (shown)

Our Santa Fe collection of edge hammered balusters are reminiscent of the old world Spanish architecture found in rustic Mexican villas. The bold, distinct hammering is the key to turning your home into an impressive estate.



Satin Black (shown)



# SANTA FE

SQUARE EDGE HAMMERED



## Finishes & Patinas

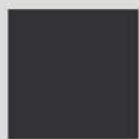

SATIN BLACK  
(STB)



**HF 16.3.8**  
Ends : 9/16" Sq.  
Height: 44"  
Wt. 3.7 lbs.



**HF 16.1.26**  
Ends : 9/16" Sq.  
Height: 44"  
Wt. 4 lbs.



**HF 16.1.27**  
Ends : 9/16" Sq.  
Height: 44"  
Wt. 4.5 lbs.



**HF 16.1.15**  
Ends : 9/16" Sq.  
Height: 44"  
Wt. 3 lbs.



**HF 16.1.22**  
Ends : 9/16" Sq.  
Height: 44"  
Wt. 3.6 lbs.

### ACCESSORIES

Level base shoes

Angled base shoes

Adjustable level base shoes

Adjustable angled base shoes

**HF16.3.3**

**HF16.3.17**

**HF16.3.44, HF16.3.46**

**HF16.3.45, HF16.3.47**

Photos: A.

Photos: E.

Photos: R.

Photos: S.

For photos and full accessory details see pages 46-47





# GOTHIC

Oil Rubbed Copper (shown)

The inspiration for our Gothic series was the timeless ironwork featured in many European castles and estates. These prominent designs will compliment old world hardware and fixtures found throughout many homes today.

Oil Rubbed Copper (shown)

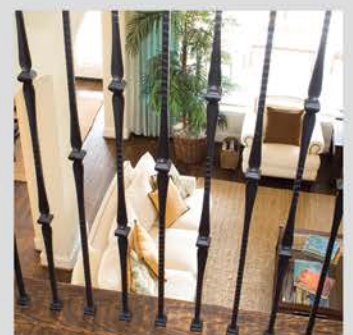

# GOTHIC

Square Face Hammered



## Finishes & Patinas



RAW IRON  
(RAW)



SATIN BLACK  
(STB)



COPPER VEIN  
(CV)



OIL RUBBED  
BRONZE  
(ORB)



OIL RUBBED  
COPPER  
(ORC)



NEWEL

**HF 16.5.6**  
Ends : 1-3/16" Sq.  
Height: 48"  
Wt. 22 lbs.



**HF 16.1.7**  
Ends : 9/16" Sq.  
Height: 44"  
Wt. 4 lbs.



**HF 16.5.2**  
Ends : 9/16" Sq.  
Height: 44"  
Wt. 3.5 lbs.



**HF 16.1.8**  
Ends : 9/16" Sq.  
Height: 44"  
Wt. 3.8 lbs.



**HF 16.1.9**  
Ends : 9/16" Sq.  
Height: 44"  
Wt. 4.5 lbs.

## ACCESSORIES

Level base shoes

Level base collars

Angled base shoes

Adjustable level base shoes

Adjustable angled base shoes

Newel mounting kit

**HF16.3.3, HF16.3.20, HF16.3.25**

**HF16.3.41, HF16.3.42**

**HF16.3.17, HF16.3.28**

**HF16.3.44, HF16.3.46**

**HF16.3.45, HF16.3.47**

**HF16.2.3**

Photos: A. A. C.

Photos: D. H.

Photos: E. G.

Photos: R.

Photos: S.

Photos: T.

For photos and full accessory details see pages 46-47





Satin Black (shown)

The style of this collection provides a sleek appearance that strikes a perfect balance between traditional and contemporary.

Antique Nickel (shown)

# ROUND



Oil Rubbed Bronze (shown)



Copper Vein (shown)



Copper Vein (shown)

# ROUND

ROUND SMOOTH



## Finishes & Patinas



RAW IRON  
(RAW)



SATIN BLACK  
(STB)



COPPER VEIN  
(CV)



OIL RUBBED  
BRONZE  
(ORB)



ASH GREY  
(AG)

	NEWELS	HF16.5.10	HF16.5.11	HF16.5.11-T	HF1.1.19	BALUSTERS	HF16.2.2	HF16.1.17	HF16.1.18	HF16.1.19	HF16.1.20	HF16.1.25-R	HF2.11.3	HF2.11.3-T	HF2.11.4	HF2.11.4-T	HF2.11.16	HF2.11.16-T	HF2.8.18	HF2.8.18-T	
RAW			•		•							•	•	•	•	•	•	•	•	•	
STB		•	•		•		•	•	•	•	•	•	•	•	•	•	•	•	•	•	•
CV		•	•				•	•	•	•	•	•									
ORB			•		•							•	•	•	•	•	•	•	•	•	•
AG				•																	•



NEWEL

**HF 16.5.10**  
Ends : 1-3/16" Rd.  
Height: 48"  
Wt. 19 lbs.



NEWEL

**HF 16.5.11**  
Ends : 1-3/16" Rd.  
Height: 48"  
Wt. 19 lbs.  
**SOLID**

**HF 16.5.11-T**  
Ends : 1-3/16" Rd.  
Height: 48"  
Wt. 5.7 lbs.  
**TUBULAR**



**HF 16.2.2**  
Ends : 9/16" Rd.  
Height: 44"  
Wt. 2.7 lbs.



**HF 16.1.17**  
Ends : 9/16" Rd.  
Height: 44"  
Wt. 2.7 lbs.



**HF 16.1.18**  
Ends : 9/16" Rd.  
Height: 44"  
Wt. 3 lbs.



**HF 16.1.19**  
Ends : 9/16" Rd.  
Height: 44"  
Wt. 4 lbs.



**HF 16.1.20**  
Ends : 9/16" Rd.  
Height: 44"  
Wt. 5 lbs.

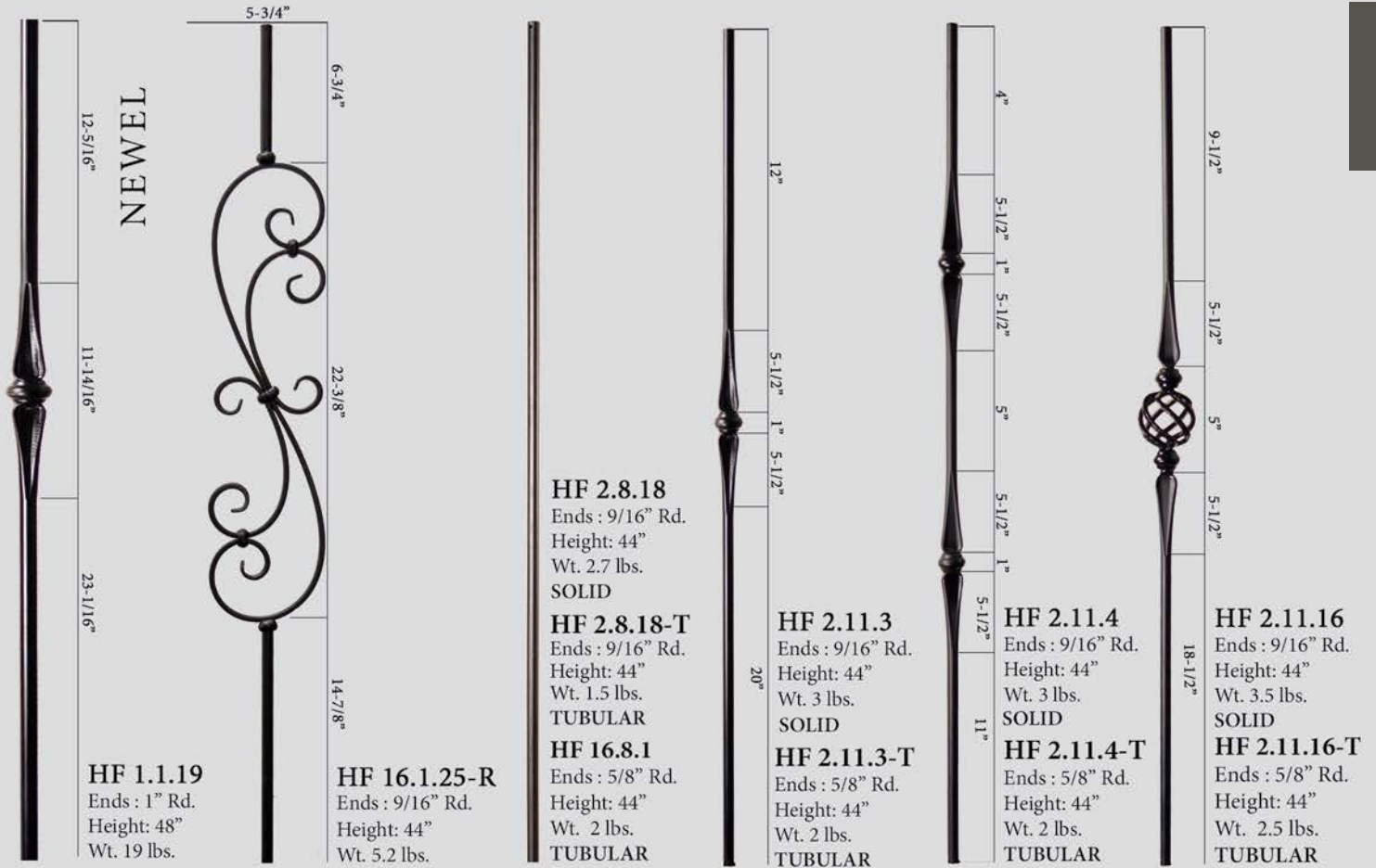

## ACCESSORIES

Level base shoes	<b>HF16.3.13, HF16.3.26</b>
Level base collars	<b>HF16.3.40, HF16.3.43</b>
Angled base shoes	<b>HF16.3.16, HF16.3.27</b>
Adjustable level base shoes	<b>HF16.3.44, HF16.3.46</b>
Adjustable angled base shoes	<b>HF16.3.45, HF16.3.47</b>
Level base shoe, fits 5/8"	<b>HF16.3.35</b>
Angled base shoe, fits 5/8"	<b>HF16.3.36</b>
Newel mounting kit	<b>HF16.3.33</b>

Photos: L. J.  
Photos: K. O.  
Photos: M. N.  
Photos: R.  
Photos: S.  
Photos: J.  
Photos: N.  
Photos: U.

For photos and full accessory details see pages 46-47





Oil Rubbed Bronze (shown)

Scrolls have consistently remained the heart and soul of ornamental iron. The ornate styles in this series can be used to create bold, dramatic patterns or combine them with less ornate balusters as an accent.

Oil Rubbed Copper (shown)



# SCROLLS



Oil Rubbed Bronze (shown)

# SCROLLS

SQUARE



## Finishes & Patinas



RAW IRON  
(RAW)



SATIN BLACK  
(STB)



SILVER VEIN  
(SP)



COPPER VEIN  
(CV)



OIL RUBBED  
BRONZE  
(ORB)



OIL RUBBED  
COPPER  
(ORC)



ANTIQUE  
NICKEL  
(AN)



ASH GREY  
(AG)

	BALUSTERS	HF16.1.25	HF16.1.25-T	HF16.1.25-S	HF16.1.41	HF16.1.24	HF13.9.1	HF13.9.2	HF13.9.3
RAW		•	•						
STB		•	•	•	•	•	•	•	•
AG			•						
SP		•	•						
CV		•	•						
ORB		•	•	•					
ORC		•	•	•					
AN		•							



**HF 16.1.25**  
Ends : 1/2" Sq.  
Height: 44"  
Wt. 5.2 lbs.  
SOLID

**HF 16.1.25-T**  
Ends : 1/2" Sq.  
Height: 44"  
Wt. 3.85 lbs.  
TUBULAR



**HF 16.1.25-S**  
Ends : 1/2" Sq.  
Height: 44"  
Wt. 5.2 lbs.



**HF 16.1.41**  
Ends : 1/2" Sq.  
Height: 44"  
Wt. 7 lbs.



**HF 16.1.24**  
Ends : 1/2" Sq.  
Height: 44"  
Wt. 7.5 lbs.



**HF 13.9.1**  
 Ends : 1/2" Sq.  
 Height: 44"  
 Wt. 5.5 lbs.



**HF 13.9.2**  
 Ends : 1/2" Sq.  
 Height: 44"  
 Wt. 5.5 lbs.



**HF 13.9.3**  
 Ends : 1/2" Sq.  
 Height: 44"  
 Wt. 5.5 lbs.

**ACCESSORIES**

- Level base shoes
- Level base collars
- Angled base shoes
- Adjustable level base shoes
- Adjustable angled base shoes

- HF16.3.1, HF16.3.19, HF16.3.29**
- HF16.3.4, HF16.3.5,**
- HF16.3.2, HF16.3.30**
- HF16.3.44, HF16.3.46**
- HF16.3.45, HF16.3.47**

- Photos: A. A. C.
- Photos: D. H.
- Photos: E. G.
- Photos: R.
- Photos: S.

For photos and full accessory details see pages 46-47 



Copper Vein (shown)

The endless baluster combinations in this series offers a match for your individual taste and style. These balusters compliment our Scroll, Twist and Ribbon series.

Silver Vein (shown)

VERSATILE



# VERSATILE SQUARE



## Finishes & Patinas



RAW IRON  
(RAW)

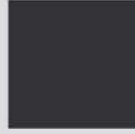

SATIN BLACK  
(STB)

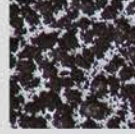

SILVER VEIN  
(SP)



COPPER VEIN  
(CV)

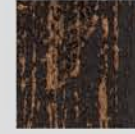

OIL RUBBED  
BRONZE  
(ORB)



OIL RUBBED  
COPPER  
(ORC)

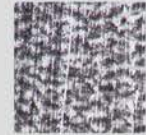

ANTIQUE  
NICKEL  
(AN)



ASH GREY  
(AG)

	NEWELS	HF16.5.8	HF16.5.8-T	HF16.5.9	HF16.5.9-T	BALUSTERS	HF16.2.1	HF16.2.1-T	HF16.1.34	HF16.1.34-T	HF16.1.35	HF16.1.35-T	HF16.1.45	HF16.1.45-T	HF16.1.30	HF16.1.30-T	HF16.1.31	HF16.1.31-T	HF16.1.32	HF2.10.1	HF2.2.3	
RAW		•		•			•	•	•	•	•	•	•	•	•		•		•	•	•	•
STB		•		•			•	•	•	•	•	•	•	•	•		•		•	•	•	•
AG			•		•			•		•		•				•		•				
SP		•		•			•	•	•	•	•	•	•	•	•		•		•	•	•	•
CV		•		•			•	•	•	•	•	•	•	•	•		•		•	•	•	•
ORB		•		•			•	•	•	•	•	•	•	•	•						•	•
ORC		•		•			•	•	•	•	•	•	•	•	•						•	•
AN		•		•			•		•		•		•									



NEWEL

**HF 16.5.8**  
Ends : 1-3/16" Sq.  
Height: 48"  
Wt. 19 lbs.  
SOLID

**HF 16.5.8-T**  
Ends : 1-3/16" Sq.  
Height: 48"  
Wt. 4.8 lbs.  
TUBULAR



NEWEL

**HF 16.5.9**  
Ends : 1-3/16" Sq.  
Height: 48"  
Wt. 20 lbs.  
SOLID

**HF 16.5.9-T**  
Ends : 1-3/16" Sq.  
Height: 48"  
Wt. 9.7 lbs.  
TUBULAR



**HF 16.2.1**  
Ends : 1/2" Sq.  
Height: 44"  
Wt. 3 lbs.  
SOLID

**HF 16.2.1-T**  
Ends : 1/2" Sq.  
Height: 44"  
Wt. 1.2 lbs.  
TUBULAR



**HF 16.1.34**  
Ends : 1/2" Sq.  
Height: 44"  
Wt. 4 lbs.  
SOLID

**HF 16.1.34-T**  
Ends : 1/2" Sq.  
Height: 44"  
Wt. 1.35 lbs.  
TUBULAR



**HF 16.1.35**  
Ends : 1/2" Sq.  
Height: 44"  
Wt. 3.5 lbs.  
SOLID

**HF 16.1.35-T**  
Ends : 1/2" Sq.  
Height: 44"  
Wt. 1.5 lbs.  
TUBULAR



**HF 16.1.45**  
Ends : 1/2" Sq.  
Height: 44"  
Wt. 4 lbs.  
SOLID

**HF 16.1.45-T**  
Ends : 1/2" Sq.  
Height: 44"  
Wt. 1.55 lbs.  
TUBULAR

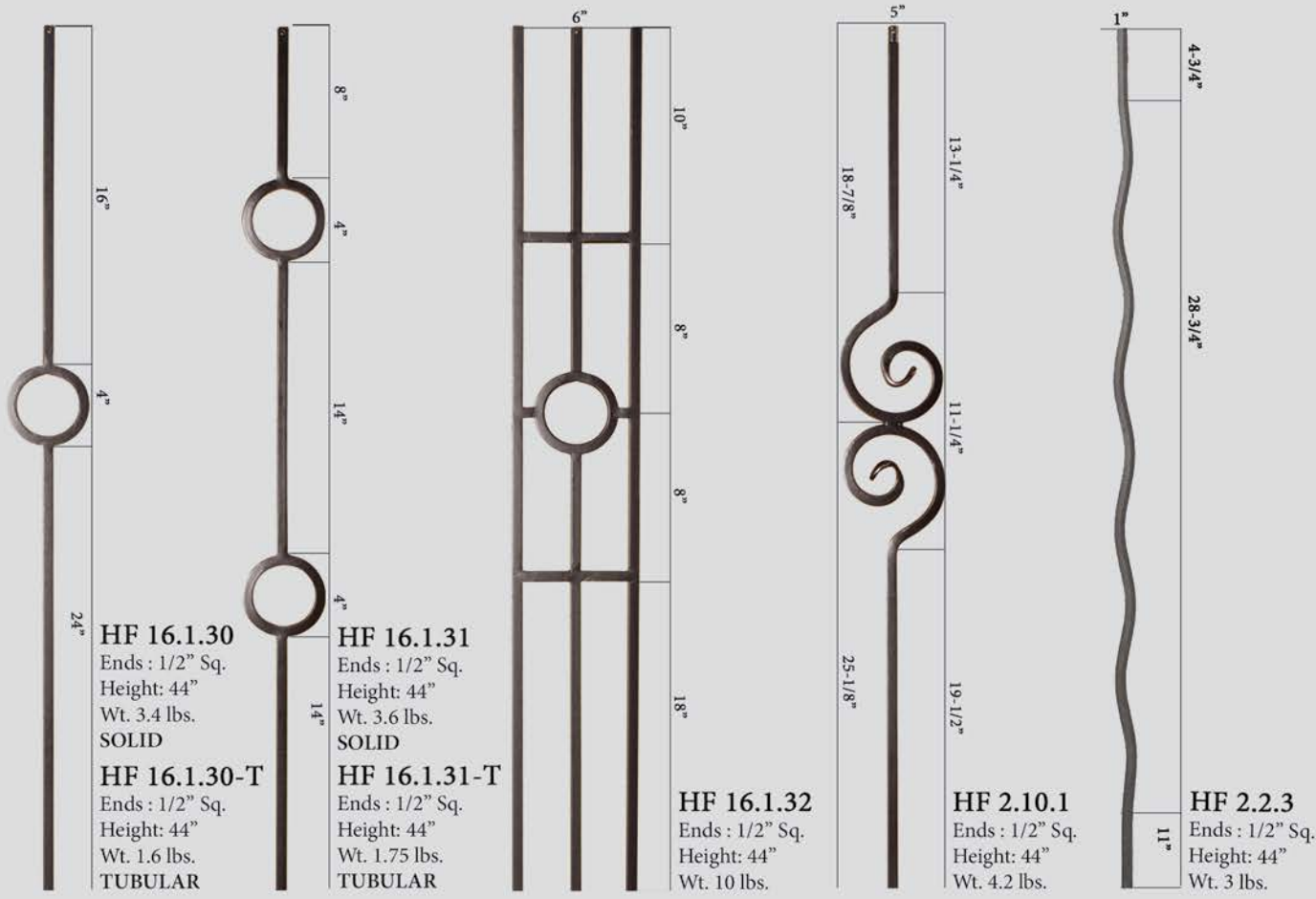

**ACCESSORIES**

- Level base shoes **HF16.3.1, HF16.3.19, HF16.3.29**
- Level base collars **HF16.3.4, HF16.3.5,**
- Angled base shoes **HF16.3.2, HF16.3.30**
- Adjustable level base shoes **HF16.3.44, HF16.3.46**
- Adjustable angled base shoes **HF16.3.45, HF16.3.47**
- Versatile style knuckle **HF16.5.1**
- Newel mounting kit **HF16.2.3**

- Photos: A. A. C.
- Photos: D. H.
- Photos: E. G.
- Photos: R.
- Photos: S.
- Photos: F.
- Photos: T.

For photos and full accessory details see pages 46-47 



**HF 16.4.3**  
Medallion, 4" Diameter  
For use with: **HF16.1.30, HF16.1.31, HF16.1.32**

- Screw Together and set permanently with epoxy
- Available in Satin Black (STB) only



Satin Black (shown)

The ribbon style twist in this series pairs nicely with balusters from the Scroll and Versatile series. The ribbon is accented nicely by the Oil Rubbed Bronze patina as well as the Copper Vein finish.

Copper Vein (shown)



RIBBON



# RIBBON SQUARE



## Finishes & Patinas



RAW IRON (RAW)



SATIN BLACK (STB)



COPPER VEIN (CV)



OIL RUBBED BRONZE (ORB)



OIL RUBBED COPPER (ORC)

	NEWELS	HF16.5.7	BALUSTERS	HF16.1.5	HF16.1.6	HF16.3.6	HF16.3.7	HF16.1.10	HF16.1.11
RAW		•		•	•				
STB		•		•	•	•	•	•	•
CV		•		•	•	•	•	•	•
ORB		•		•	•	•	•	•	•
ORC		•		•	•	•	•	•	•





**HF 16.1.10**  
 Ends : 1/2" Sq.  
 Height: 44"  
 Wt. 3.6 lbs.



**HF 16.1.11**  
 Ends : 1/2" Sq.  
 Height: 44"  
 Wt. 4.1 lbs.

## ACCESSORIES

Level base shoes	<b>HF16.3.1, HF16.3.19, HF16.3.29</b>
Level base collars	<b>HF16.3.4, HF16.3.5,</b>
Angled base shoes	<b>HF16.3.2, HF16.3.30</b>
Adjustable level base shoes	<b>HF16.3.44, HF16.3.46</b>
Adjustable angled base shoes	<b>HF16.3.45, HF16.3.47</b>
Versatile style knuckle	<b>HF16.5.1</b>
Newel mounting kit	<b>HF16.2.3</b>

Photos: A. A. C.  
 Photos: D. H.  
 Photos: E. G.  
 Photos: R.  
 Photos: S.  
 Photos: F.  
 Photos: T.

For photos and full accessory details see pages 46-47





Copper Vein (shown)

This popular twist and basket design is a mainstay featured in many new homes. These balusters and newels are offered in an extensive range of finishes and patinas. They combine seamlessly with profiles from the Scroll and Versatile series.

Oil Rubbed Copper (shown)

# TWIST



Satin Black (shown)



Oil Rubbed Bronze (shown)



Antique Nickel (shown)

# TWIST SQUARE



## Finishes & Patinas



RAW IRON (RAW)



SATIN BLACK (STB)



SILVER VEIN (SP)



COPPER VEIN (CV)



OIL RUBBED BRONZE (ORB)



OIL RUBBED COPPER (ORC)

	NEWELS	HF16.5.4	HF16.5.4-T	HF16.5.5	HF16.5.5-T	BALUSTERS	HF16.1.1	HF16.1.1-T	HF16.1.2	HF16.1.2-T	HF16.1.3	HF16.1.3-T	HF16.1.4	HF16.1.4-T	HF16.1.21	HF16.1.21-T	HF16.1.16	HF16.2.4	HF16.2.5	HF16.2.6	
RAW		•		•		•	•	•	•	•	•	•	•	•	•	•		•	•	•	•
STB		•		•		•	•	•	•	•	•	•	•	•	•	•		•	•	•	•
AG			•		•																
SP		•		•		•	•	•	•	•	•	•	•	•	•		•				
CV		•		•		•	•	•	•	•	•	•	•	•			•	•	•	•	•
ORB		•		•		•	•	•	•	•	•	•	•	•		•	•	•	•	•	•
ORC		•		•		•	•	•	•	•	•	•	•	•		•	•	•	•	•	•
AN		•		•		•	•	•	•	•	•	•	•	•	•		•				



ANTIQUE NICKEL (AN)



ASH GREY (AG)

**NEWEL**

13-1/4"  
11-1/2"  
23-1/4"

**HF 16.5.4**  
Ends : 1-3/16" Sq.  
Height: 48"  
Wt. 18 lbs.  
SOLID

**HF 16.5.4-T**  
Ends : 1-3/16" Sq.  
Height: 48"  
Wt. 5.5 lbs.  
TUBULAR

**NEWEL**

5-1/2"  
7-1/4"  
3-1/2"  
6-1/2"  
3-1/2"  
7-1/4"  
14-1/2"

**HF 16.5.5**  
Ends : 1-3/16" Sq.  
Height: 48"  
Wt. 20 lbs.  
SOLID

**HF 16.5.5-T**  
Ends : 1-3/16" Sq.  
Height: 48"  
Wt. 7.6 lbs.  
TUBULAR

15"  
6"  
23"

**HF 16.1.1**  
Ends : 1/2" Sq.  
Height: 44"  
Wt. 3 lbs.  
SOLID

**HF 16.1.1-T**  
Ends : 1/2" Sq.  
Height: 44"  
Wt. 1.2 lbs.  
TUBULAR

9"  
6"  
6"  
6"  
17"

**HF 16.1.2**  
Ends : 1/2" Sq.  
Height: 44"  
Wt. 3 lbs.  
SOLID

**HF 16.1.2-T**  
Ends : 1/2" Sq.  
Height: 44"  
Wt. 1.15 lbs.  
TUBULAR

6"  
6"  
3"  
5-1/2"  
3-1/2"  
6"  
14"

**HF 16.1.3**  
Ends : 1/2" Sq.  
Height: 44"  
Wt. 4 lbs.  
SOLID

**HF 16.1.3-T**  
Ends : 1/2" Sq.  
Height: 44"  
Wt. 1.55 lbs.  
TUBULAR

8"  
5-1/2"  
8"  
5-1/2"  
17"

**HF 16.1.4**  
Ends : 1/2" Sq.  
Height: 44"  
Wt. 4 lbs.  
SOLID

**HF 16.1.4-T**  
Ends : 1/2" Sq.  
Height: 44"  
Wt. 1.95 lbs.  
TUBULAR

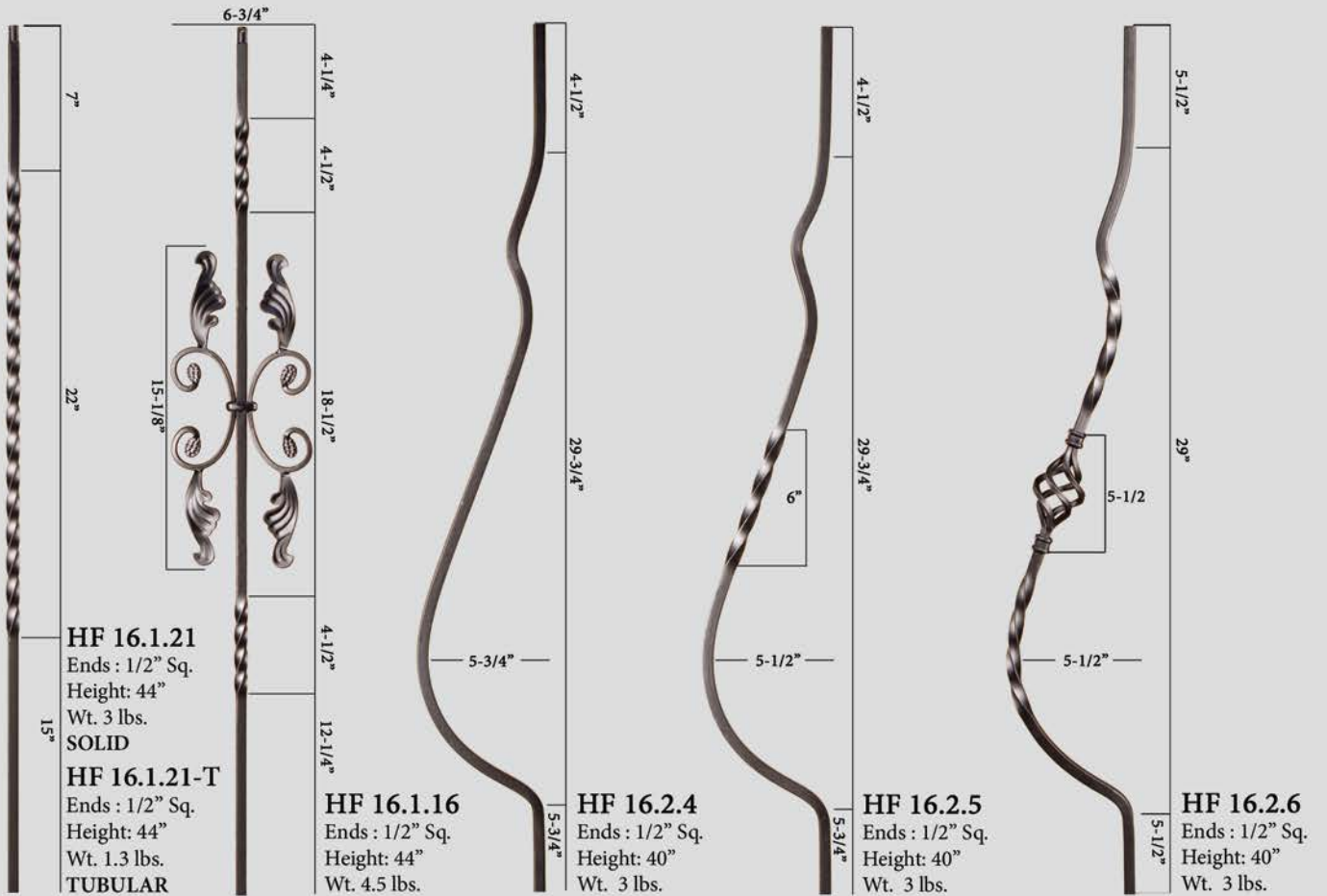

## ACCESSORIES

Level base shoes	<b>HF16.3.1, HF16.3.19, HF16.3.29</b>
Level base collars	<b>HF16.3.4, HF16.3.5,</b>
Angled base shoes	<b>HF16.3.2, HF16.3.30</b>
Adjustable level base shoes	<b>HF16.3.44, HF16.3.46</b>
Adjustable angled base shoes	<b>HF16.3.45, HF16.3.47</b>
Versatile style knuckle	<b>HF16.5.1</b>
Newel mounting kit	<b>HF16.2.3</b>

Photos: A. A. C.  
Photos: D. H.  
Photos: E. G.  
Photos: R.  
Photos: S.  
Photos: F.  
Photos: T.

For photos and full accessory details see pages 46-47



# ACCESSORY SPECIFICATIONS

Photo	Part #	Description	RAW	STB	AG	SP	CV	ORB	ORC	AN	VB	SC
<b>1/2" Square Baluster Accessories</b>												
A.	HF16.3.1	Level base shoe, fits 1/2" square balusters, 1-5/16" square base, aluminum		•		•	•		•	•		
A.	HF16.3.19	Level base shoe with set screw, fits 1/2" square balusters, 1-5/16" square base, aluminum	•	•	•	•	•	•	•	•		
E.	HF16.3.2	Angled base shoe with set screw, fits 1/2" square balusters, 1-5/16" base, aluminum	•	•	•	•	•	•	•	•		
B.	HF16.3.21	Level base shoe with screw mount, fits 1/2" square balusters, 1-9/16" square base, aluminum		•			•					
F.	HF16.5.1	Versatile style knuckle with set screw, fits 1/2" square balusters, 1-7/16" square, aluminum	•	•		•	•	•	•	•		
C.	HF16.3.29	Oil Rubbed Bronze, level base shoe with set screw, fits 1/2" square balusters, 1-1/4" square base, cast iron						•				
G.	HF16.3.30	Oil Rubbed Bronze, angled base shoe with set screw, fits 1/2" square balusters, 1-1/4" base, cast iron						•				
D.	HF16.3.4	Level base collar, fits 1/2" square balusters, 2" square base, aluminum		•			•	•	•			
H.	HF16.3.5	Level base collar, fits 1/2" square balusters, 1-5/16" round base, aluminum		•			•	•	•			
<b>9/16" Square Baluster Accessories</b>												
A.	HF16.3.3	Level base shoe, fits 9/16" square balusters, 1-5/16" square base, aluminum		•			•	•				
A.	HF16.3.20	Level base shoe with set screw, fits 9/16" square balusters, 1-5/16" square base, aluminum		•			•	•				
E.	HF16.3.17	Angled base shoe with set screw, fits 9/16" square balusters, 1-5/16" base, aluminum		•			•	•				
B.	HF16.3.22	Level base shoe with screw mount, fits 9/16" square balusters, 1-9/16" square base, aluminum		•			•					
C.	HF16.3.25	Level base shoe with set screw, fits 9/16" Tuscan square balusters, 1-1/4" square base, cast iron	•	•			•	•			•	•
G.	HF16.3.28	Angled base shoe with set screw, fits 9/16" Tuscan square balusters, 1-1/4" base, cast iron	•	•			•	•			•	•
D.	HF16.3.41	Level base collar, fits 9/16" square balusters, 2" square base, aluminum		•			•	•				
H.	HF16.3.42	Level base collar, fits 9/16" square balusters, 1-5/16" round base, aluminum		•			•	•			•	
<b>5/8" Square Baluster Accessories</b>												
C.	HF16.3.38	Level base shoe with set screw, fits 5/8" square balusters, 1-1/4" square base, cast iron	•	•				•				
G.	HF16.3.39	Angled base shoe with set screw, fits 5/8" square balusters, 1-1/4" base, cast iron	•	•				•				
<b>9/16" Round Baluster Accessories</b>												
I.	HF16.3.13	Level base shoe, fits 9/16" round balusters, 1-5/16" square base, aluminum		•	•		•					
M.	HF16.3.16	Angled base shoe with set screw, fits 9/16" round balusters, 1-5/16" base, aluminum		•	•		•					
J.	HF16.3.26	Level base shoe, fits 9/16" round balusters, 1-1/4" square base, cast iron		•			•	•			•	•
N.	HF16.3.27	Angled base shoe with set screw, fits 9/16" round balusters, 1-1/4" base, cast iron		•			•	•			•	•
K.	HF16.3.40	Level base collar, fits 9/16" round balusters, 2" square base, cast iron		•			•	•				
O.	HF16.3.43	Level base collar, fits 9/16" round balusters, 1-5/16" round base, cast iron		•			•	•			•	
L.	HF17.11.22	Level base collar, fits 9/16" round stainless steel balusters, 1-1/2" round base, stainless steel										
<b>5/8" Round Baluster Accessories</b>												
J.	HF16.3.35	Level base shoe with set screw, fits 5/8" round balusters, 1-1/4" square base, cast iron	•	•			•	•				
N.	HF16.3.36	Angled base shoe with set screw, fits 5/8" round balusters, 1-1/4" base, cast iron	•	•			•	•				
Adjustable Shoes/Collars have a flexible insert that allows them to be used with either square or round balusters ranging in size from 1/2" to 9/16". Epoxy must be used to permanently secure.												
R.	HF16.3.44	Level base shoe, fits 1/2" - 9/16" square or round balusters, 1-5/16" square base, cast iron		•			•	•			•	•
R.	HF16.3.46	Level base shoe, fits 1/2" - 9/16" square or round balusters, 1-1/2" square base, cast iron		•			•	•			•	•
S.	HF16.3.45	Angled base shoe, fits 1/2" - 9/16" square or round balusters, 1-5/16" base, cast iron		•			•	•			•	•
S.	HF16.3.47	Angled base shoe, fits 1/2" - 9/16" square or round balusters, 1-1/2" base, cast iron		•			•	•			•	•
P.	HF16.3.24	Level base collar, fits 1/2" - 9/16" square or round balusters, 1-11/16" square base, aluminum		•								
Q.	HF16.3.23	Level base collar, fits 1/2" - 9/16" square or round balusters, 1-11/16" round base, aluminum		•								
<b>Newel Mounting Kits</b>												
T.	HF16.2.3	Newel mounting kit with level base shoe, fits 1-3/16" square newels, 3-1/8" square base, cast iron	•	•	•	•	•	•	•	•		
T.	HF16.3.31	Newel mounting kit with level base shoe, fits 1" square newels, 3-1/8" square base, cast iron	•	•			•	•			•	•
U.	HF16.3.14	Newel mounting kit with level base shoe, fits 1-3/16" round newels, 3-1/8" square base, cast iron	•	•			•	•				
U.	HF16.3.33	Newel mounting kit with level base shoe, fits 1" round newels, 3-1/8" square base, cast iron	•	•	•		•	•			•	•
V.	HF17.2.3	Newel mounting kit with level base collar, fits 1-3/16" round stainless steel newels, 3-1/4" round base, stainless steel										
<b>Handrail Brackets</b>												
W.	HR3002	Handrail bracket, 1-1/4" x 2-3/8" mounting plate, extends out 3" from wall, aluminum Also available in Brushed Chrome HFBC.3002, Polished Brass HFPB.3002		•		•	•	•	•		•	•
X.	HR3003	Handrail bracket, 2-1/16" round mounting plate, extends out 3" from wall, aluminum Also available in Chrome HFCE.3003, Brushed Chrome HFBC.3003, Polished Brass HFPB.3003, Nickel HFNL.3003		•		•	•	•	•		•	•



# ACCESSORY PROFILES



## Forged Panels

**House of Forgings  
is dedicated to  
providing superior  
products that meet the  
highest standards of  
architects,  
homebuilders  
and homeowners.**

We are pleased to provide a full line of prefabricated ornamental iron components. These elegant products allow for the look and feel of a fully custom fabricated iron stair or railing system. In addition to cost savings, installation time is greatly reduced compared to traditional fabrication.

STAIR & RAILING PRODUCTS BY





Rebecca panels paired with Monte Carlo balusters (shown)

# REBECCA



Rebecca HFRB.B1 (shown)

5/8" ROUND  
IRON



1/2" ROUND  
IRON

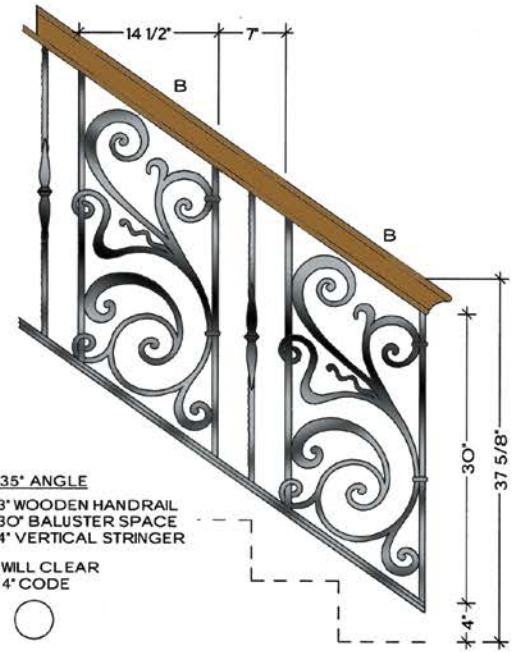

35° ANGLE  
3" WOODEN HANDRAIL  
30" BALUSTER SPACE  
4" VERTICAL STRINGER  
WILL CLEAR  
4" CODE

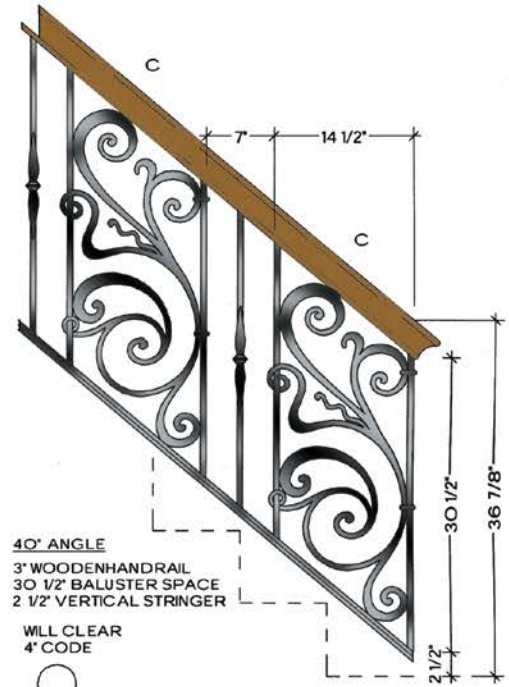

40° ANGLE  
3" WOODEN HANDRAIL  
30 1/2" BALUSTER SPACE  
2 1/2" VERTICAL STRINGER  
WILL CLEAR  
4" CODE

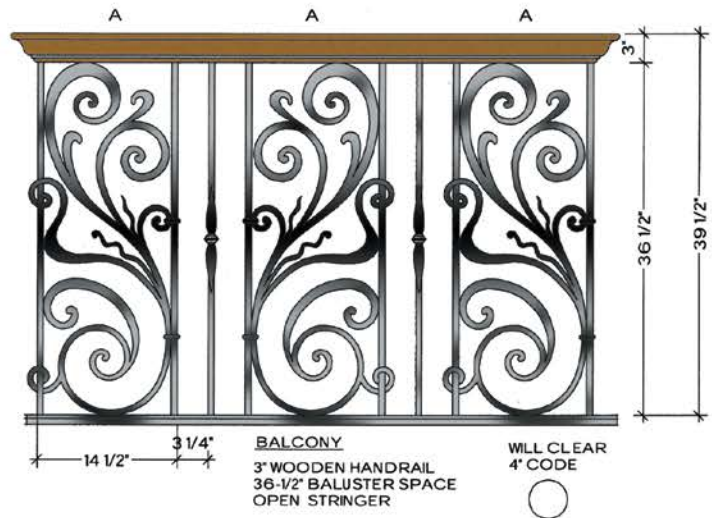

# REBECCA

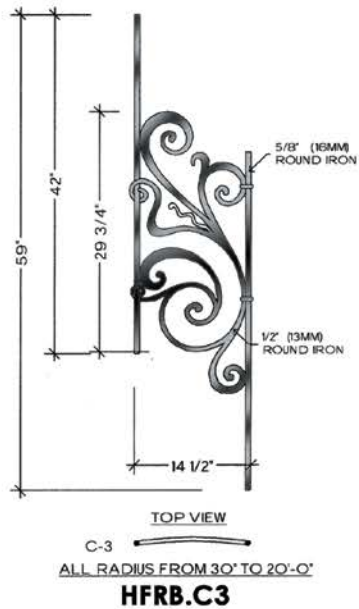
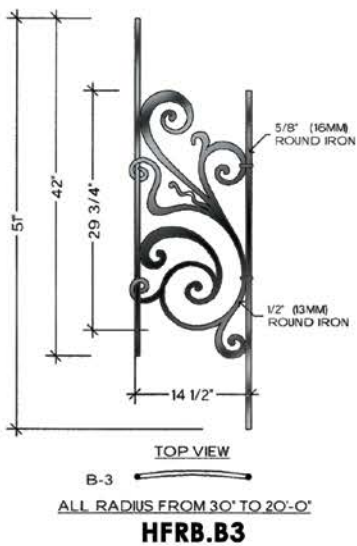
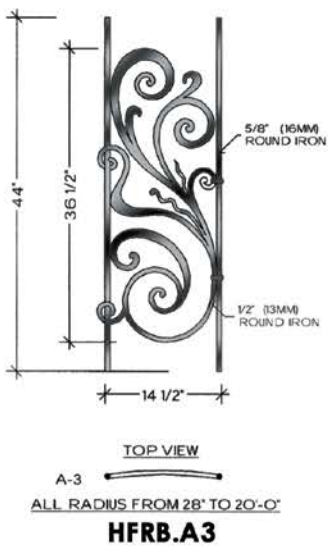
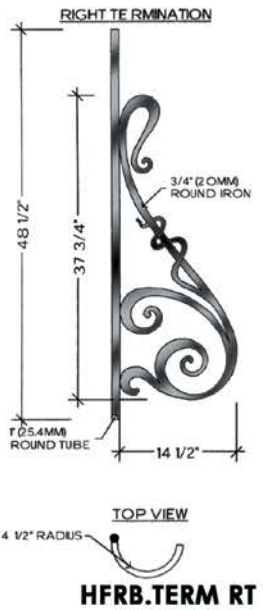
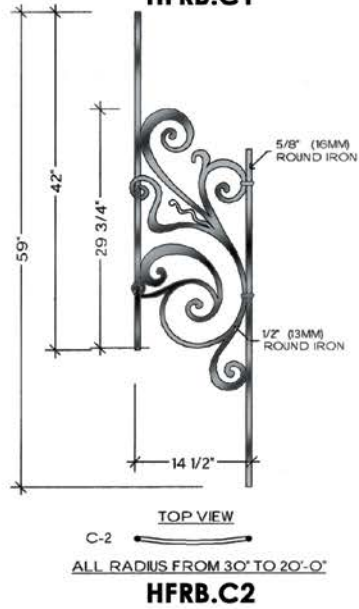
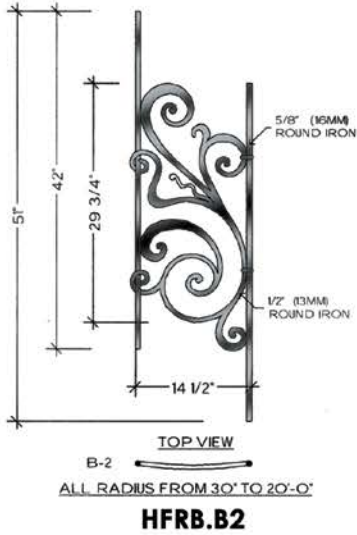
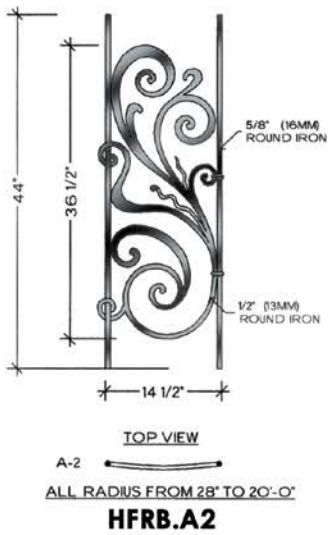
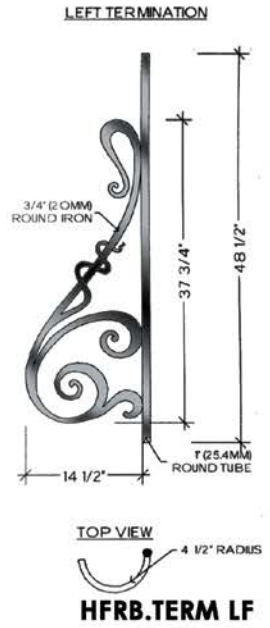
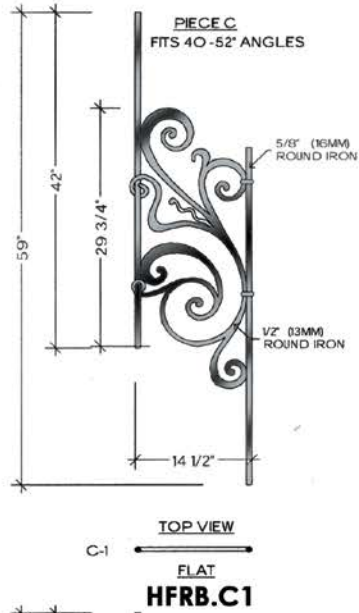
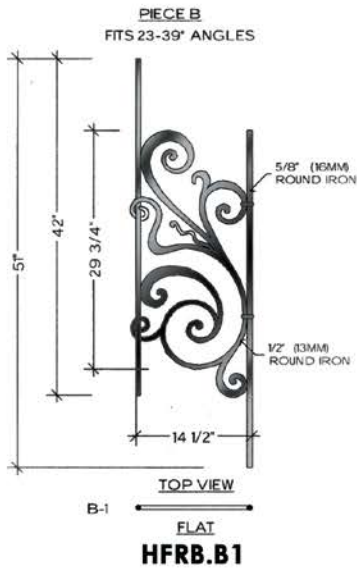
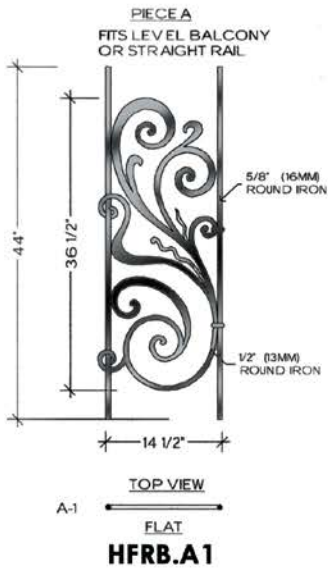

# TUSCANY



Tuscany HFTU.A1 (shown)

1/2" SQUARE  
IRON

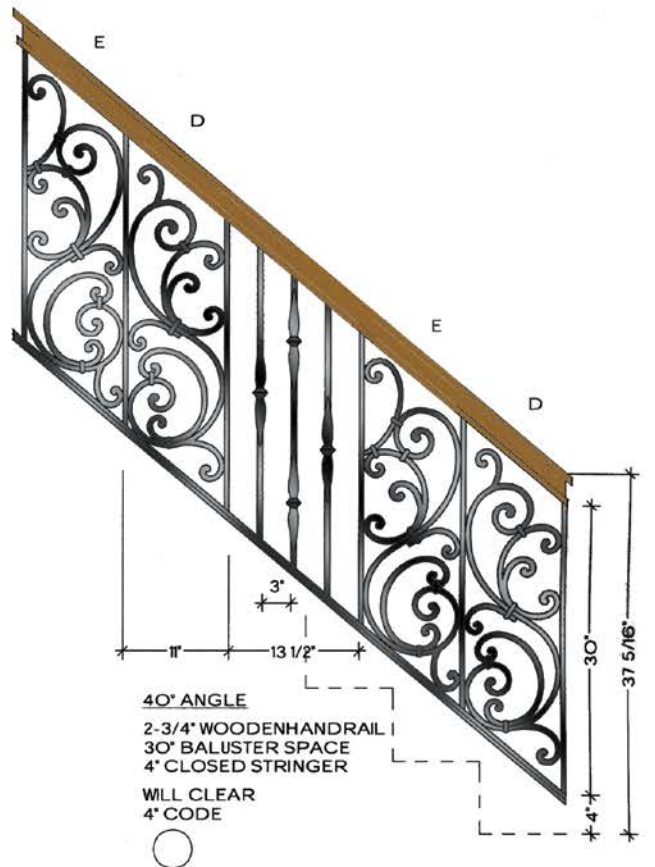
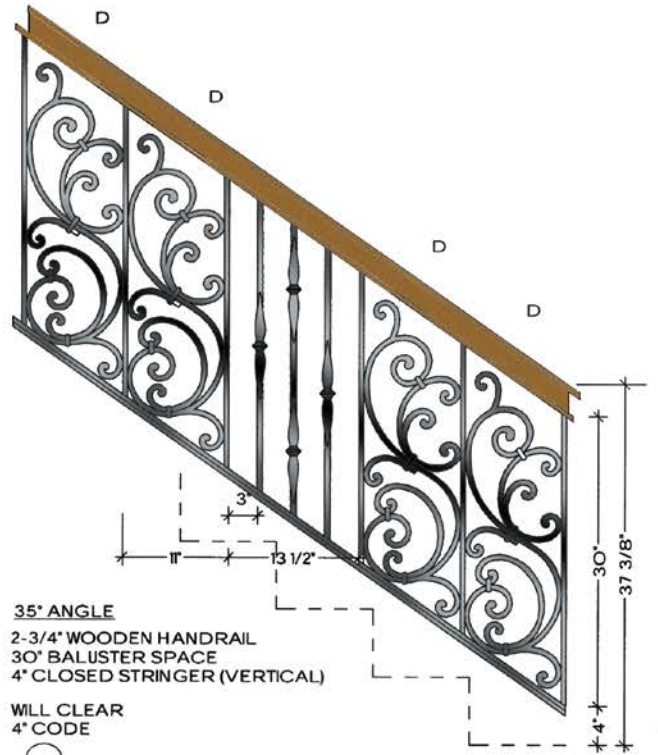

# TUSCANY

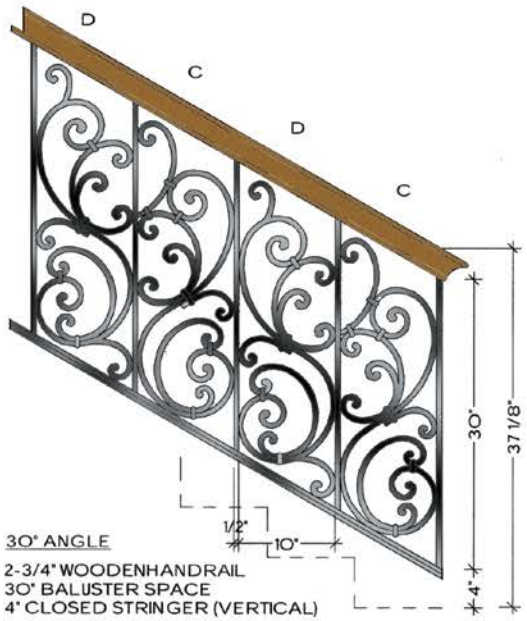

WILL CLEAR  
 4" CODE

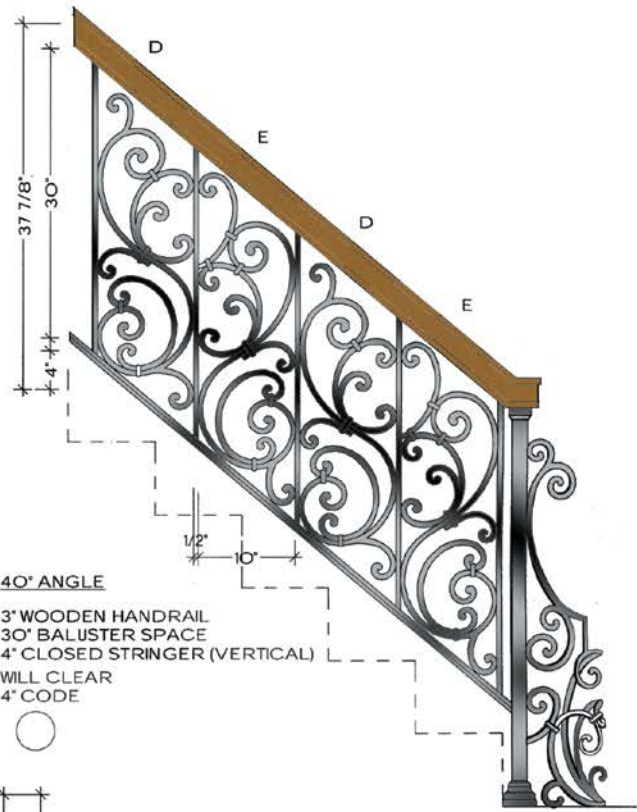

40° ANGLE

3" WOODEN HANDRAIL  
 30" BALUSTER SPACE  
 4" CLOSED STRINGER (VERTICAL)

WILL CLEAR  
 4" CODE



RIGHT TERMINATION  
 LEFT SIDE VIEW

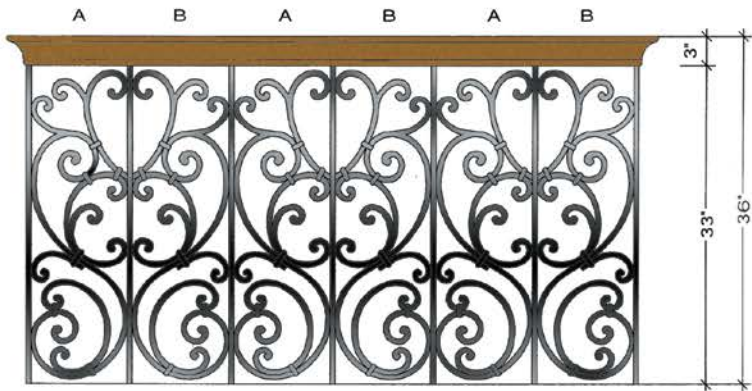

1/2" 10"

BALCONY  
 3" WOODEN HANDRAIL  
 33" BALUSTER SPACE

WILL CLEAR  
 4" CODE

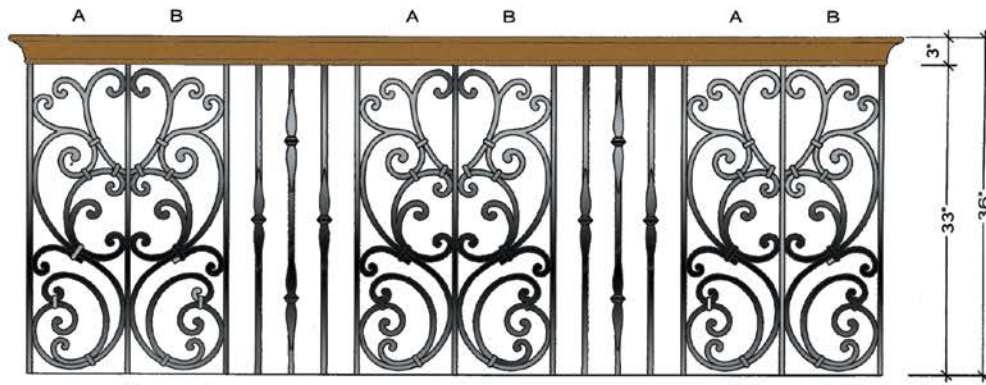

1/2" 10" 1/2" 3" 14 1/2"

BALCONY  
 3" WOODEN HANDRAIL  
 33" BALUSTER SPACE

WILL CLEAR  
 4" CODE



# TUSCANY

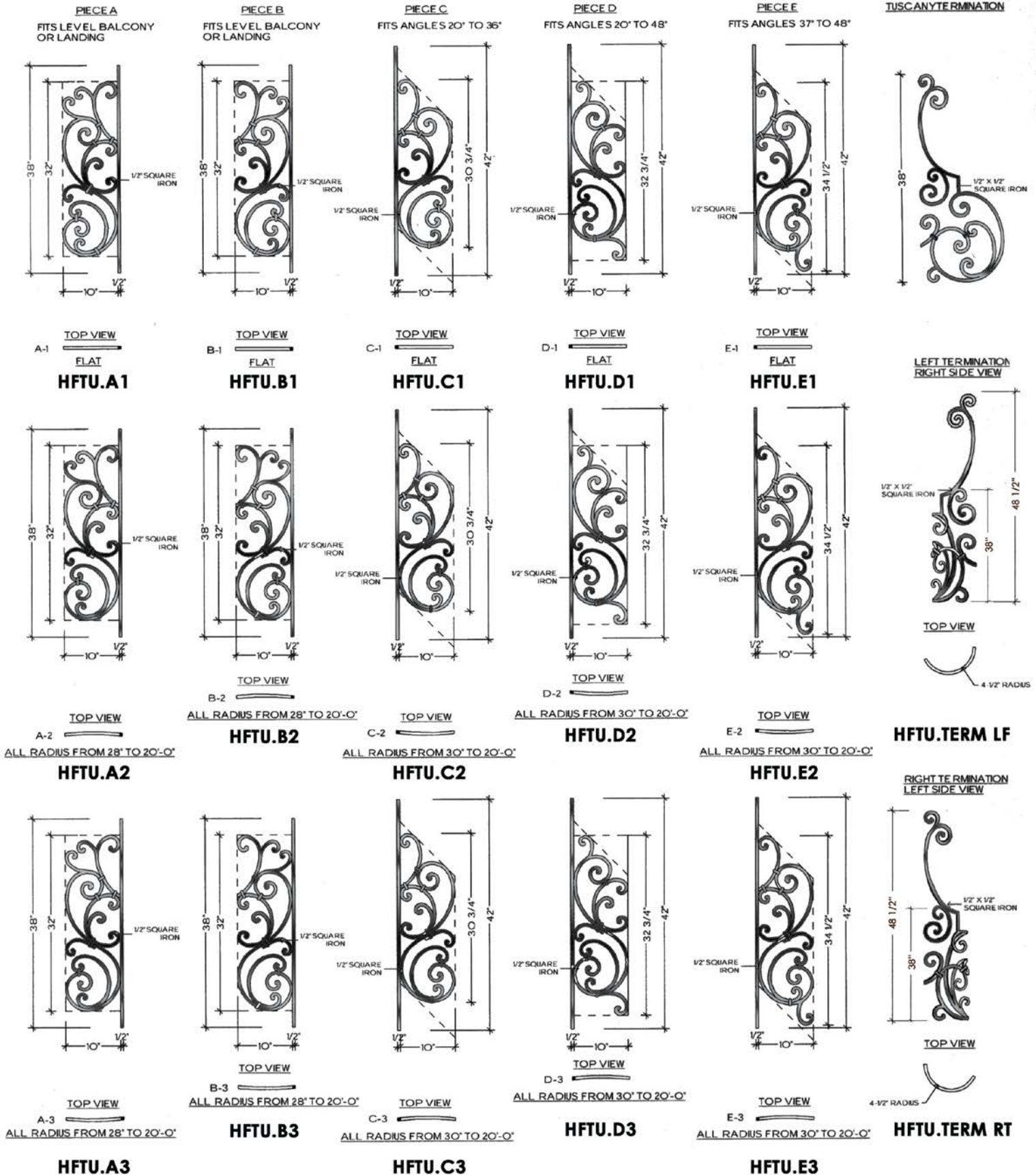





Tuscany panels paired with Gothic balusters (shown)

# SEVILLE



Seville HFSE.A1 (shown)

1/2" SQUARE IRON



45° ANGLE  
2-1/2" WOODEN HANDRAIL  
30" BALUSTER SPACE  
4" VERTICAL STRINGER

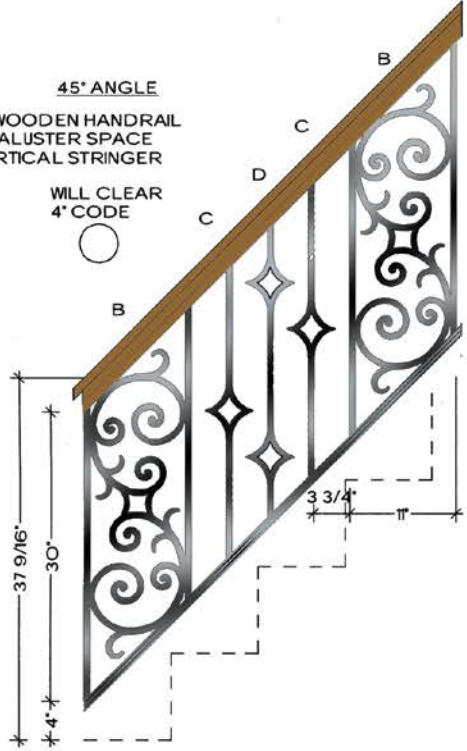

30° ANGLE  
3" WOODEN HANDRAIL  
30" BALUSTER SPACE  
4" VERTICAL STRINGER

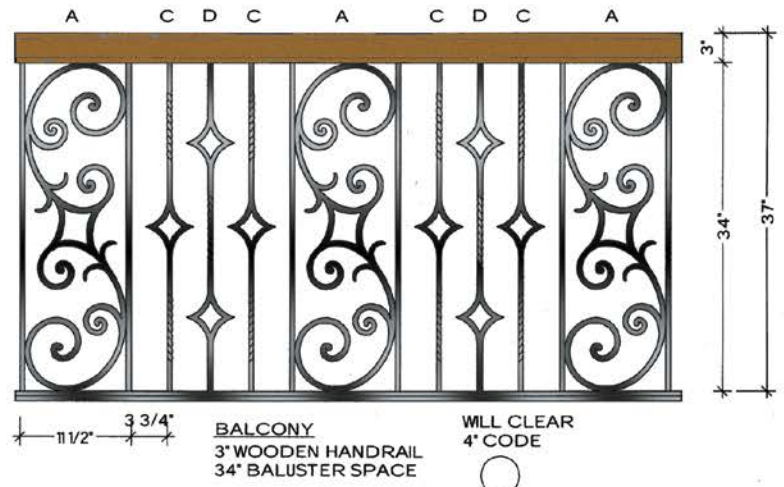
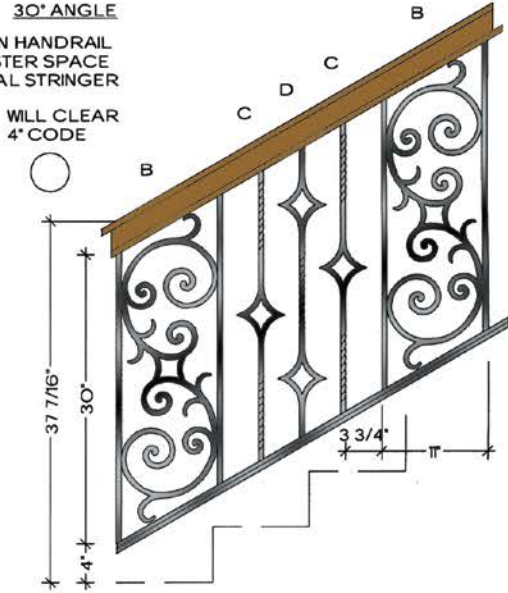

# SEVILLE

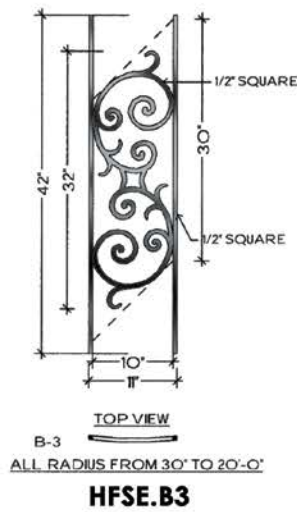
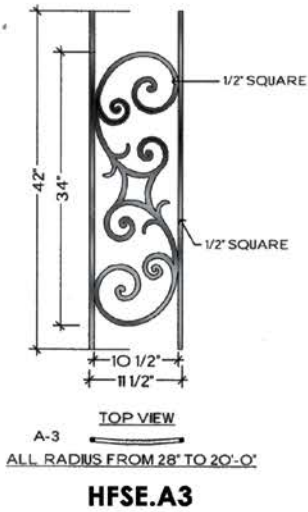
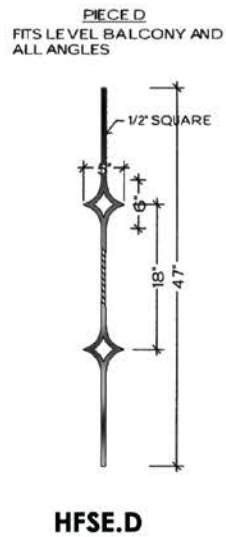
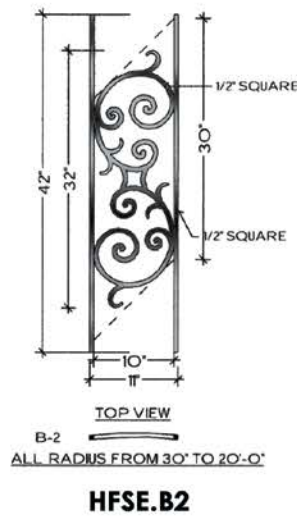
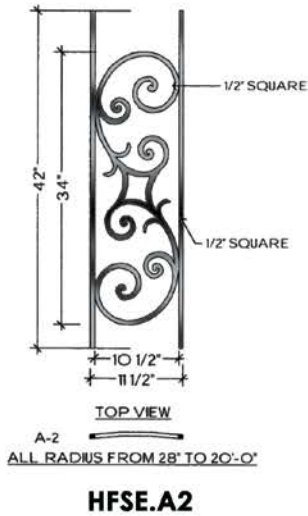
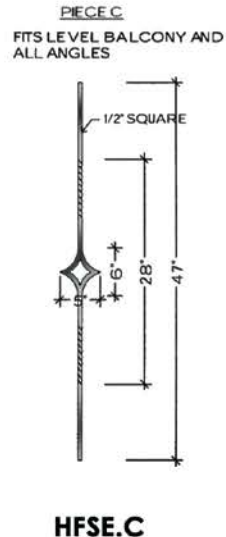
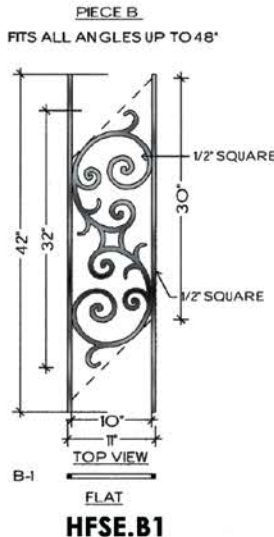
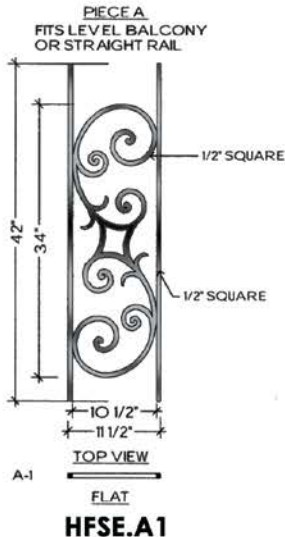

# MILANO



Milano HFMO.A1 (shown)

3/4" SQUARE TUBE



1/2" SQUARE IRON

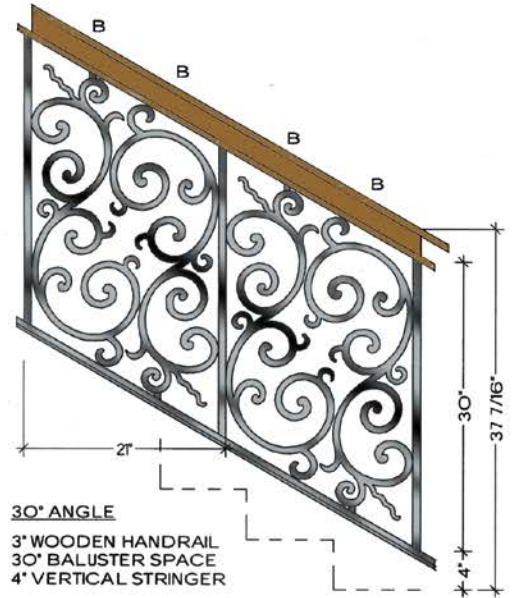

WILL CLEAR 4" CODE

NOTE: THE MILANO LAYOUT REQUIRES THE REMOVAL OF SOME ATTACHED VERTICALS AND REWELDING SCROLLS TO PREVIOUS VERTICAL

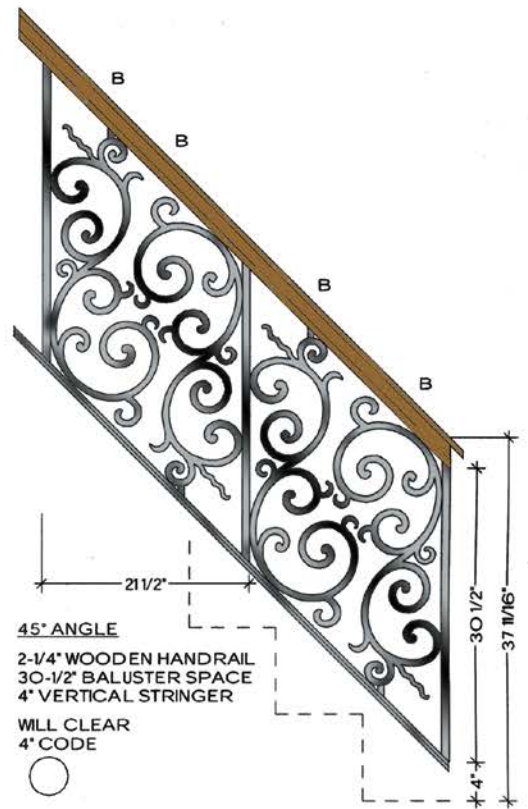

WILL CLEAR 4" CODE

# MILANO

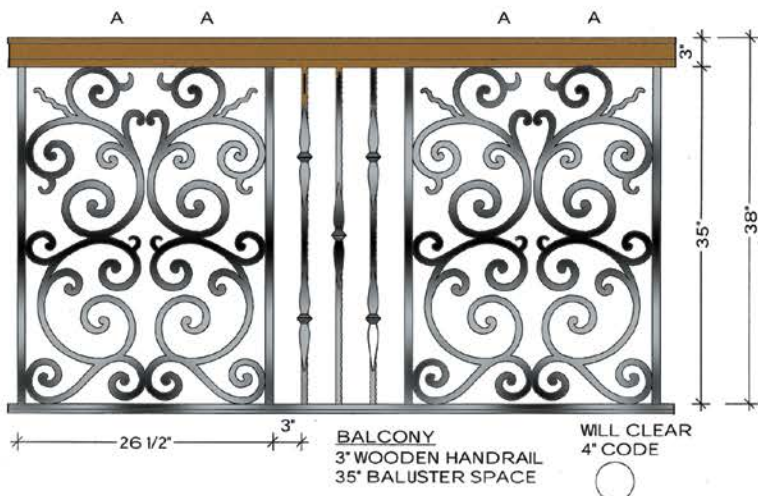
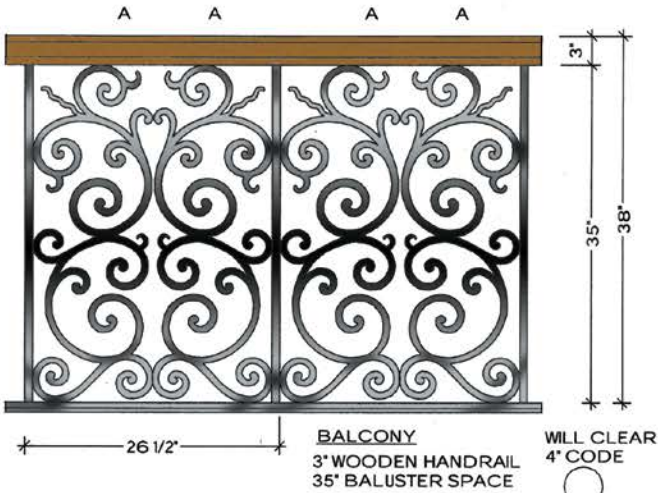
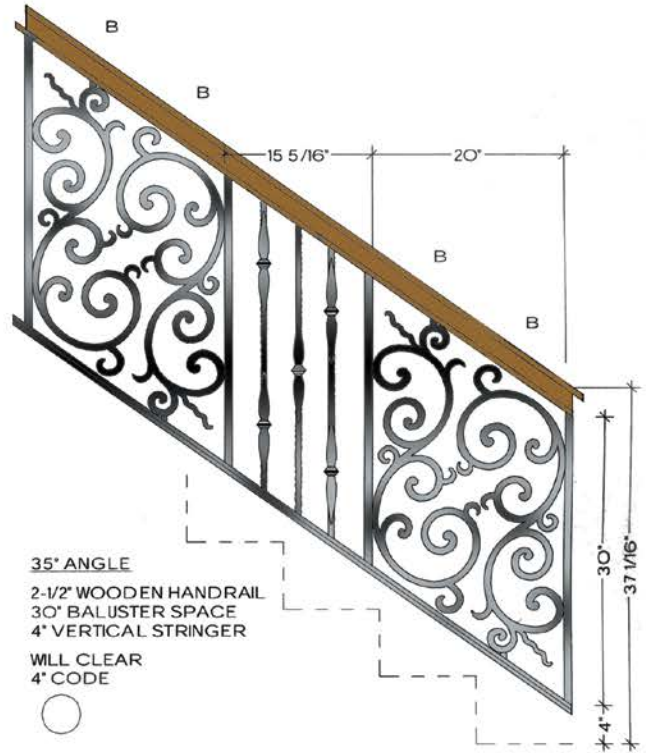
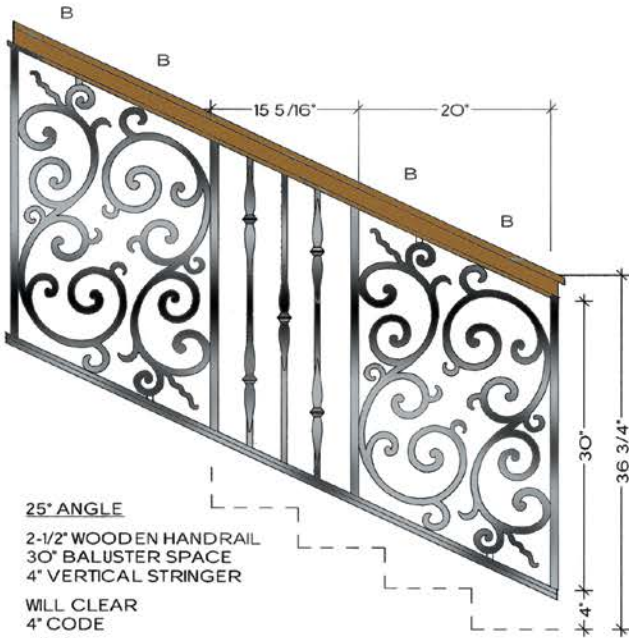

# MILANO

**PIECE A**  
FITS LEVEL BALCONY OR LANDING

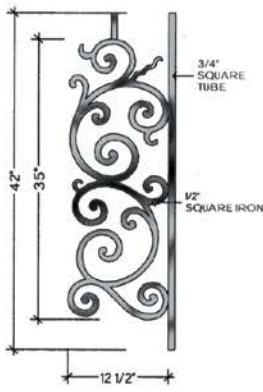

TOP VIEW  
A-1  
FLAT  
**HFM0.A1**

**PIECE B**  
FITS ALL ANGLES UP TO 48°

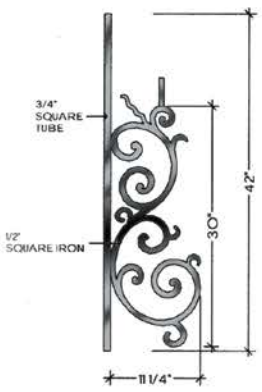

TOP VIEW  
B-1  
FLAT  
**HFM0.B1**

**PIECE B**  
FITS ALL ANGLES UP TO 48°

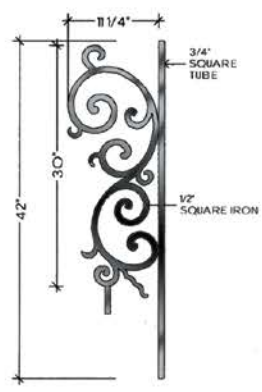

TOP VIEW  
B-1  
FLAT  
**HFM0.B1**

**TERMINATION**

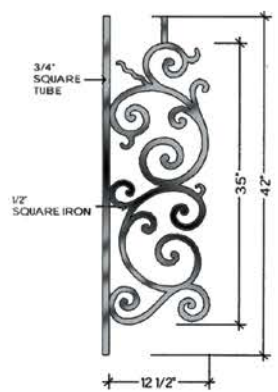
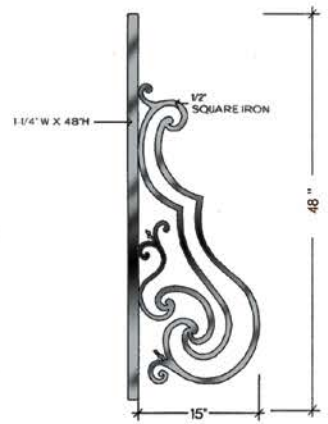

TOP VIEW  
A-2  
ALL RADIUS FROM 28° TO 20°-0°  
**HFM0.A2**

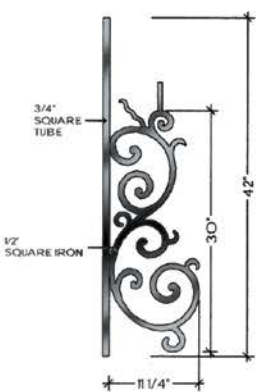

TOP VIEW  
B-2  
ALL RADIUS FROM 30° TO 20°-0°  
**HFM0.B2**

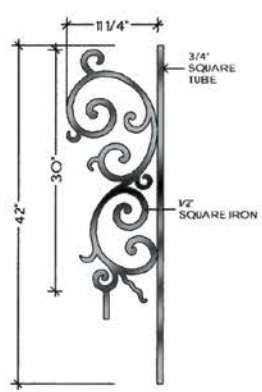

TOP VIEW  
B-2  
ALL RADIUS FROM 30° TO 20°-0°  
**HFM0.B2**

**LEFT TERMINATION**  
**RIGHT SIDE VIEW**



**HFM0.TERM LF**

**RIGHT TERMINATION**  
**LEFT SIDE VIEW**

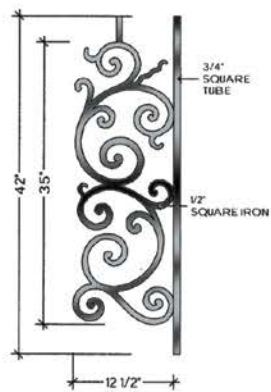

TOP VIEW  
A-3  
ALL RADIUS FROM 28° TO 20°-0°  
**HFM0.A3**

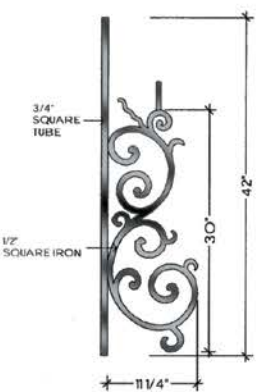

TOP VIEW  
B-3  
ALL RADIUS FROM 30° TO 20°-0°  
**HFM0.B3**

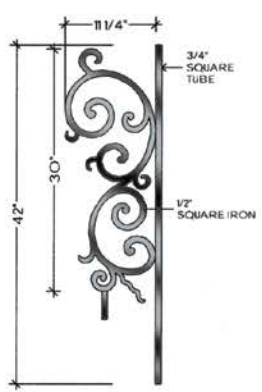

TOP VIEW  
B-3  
ALL RADIUS FROM 30° TO 20°-0°  
**HFM0.B3**



**HFM0.TERM RT**

All panels are stocked in primed black, powdercoating or faux painting is available by special order

U.S. Pat. No. 5,827,111 & No. 6,059,269



U.S. Pat.  
No. 5,827,111  
No. 6,059,269

Bordeaux panels (shown)

Regency ©  
61

# BORDEAUX



Bordeaux HFBX.A1 (shown)

3/4" SQUARE  
TUBE



5/8" SQUARE  
IRON

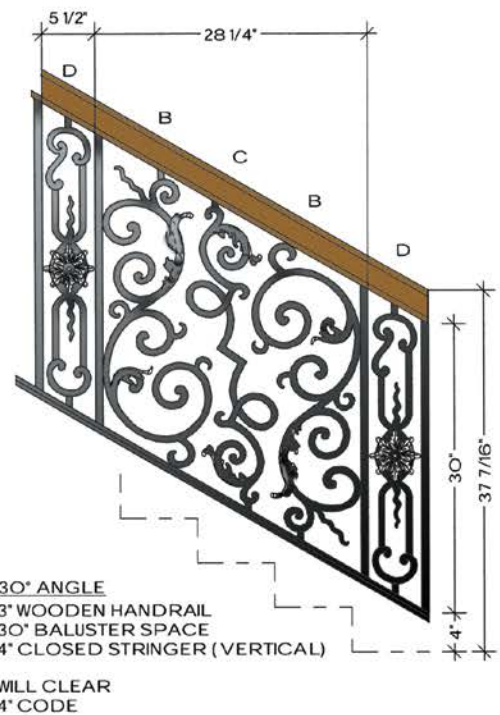
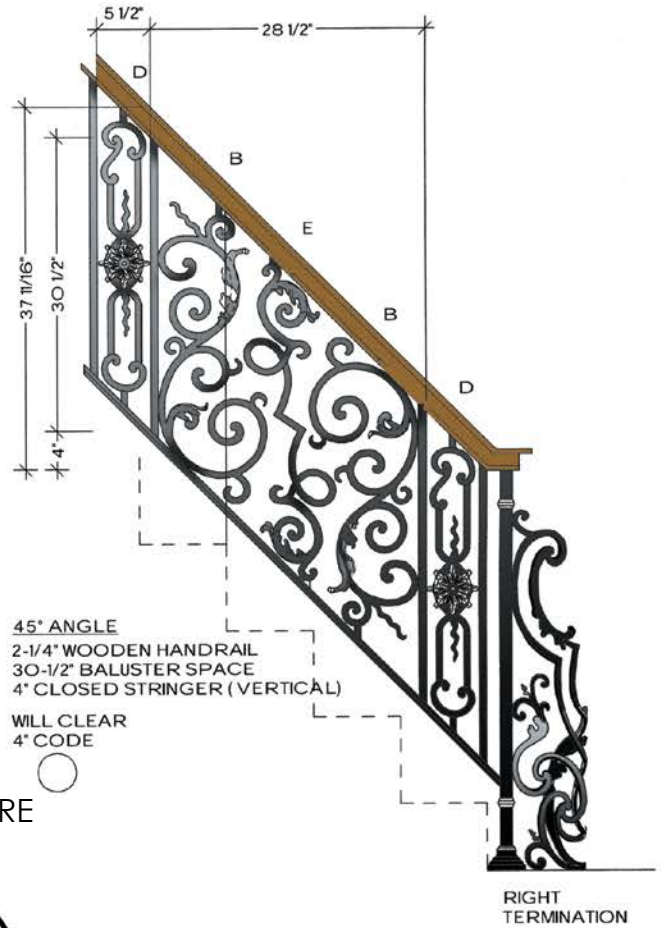



# BORDEAUX

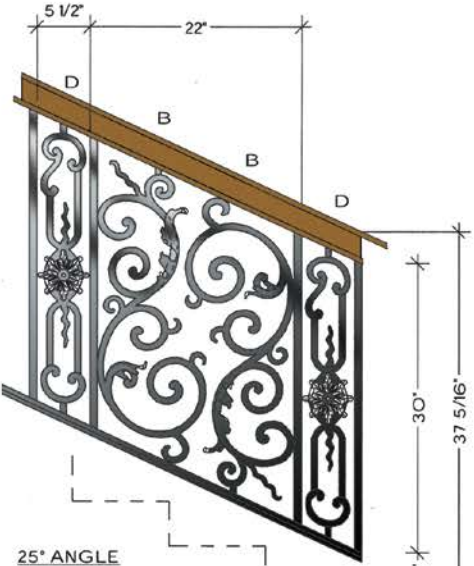

25° ANGLE  
 3" WOODEN HANDRAIL  
 30" BALUSTER SPACE  
 4" CLOSED STRINGER (VERTICAL)

WILL CLEAR  
 4" CODE

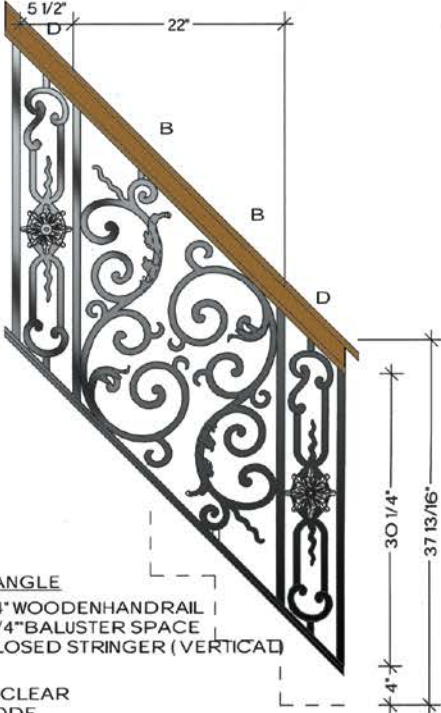

45° ANGLE  
 2-3/4" WOODEN HANDRAIL  
 30-1/4" BALUSTER SPACE  
 4" CLOSED STRINGER (VERTICAL)

WILL CLEAR  
 4" CODE

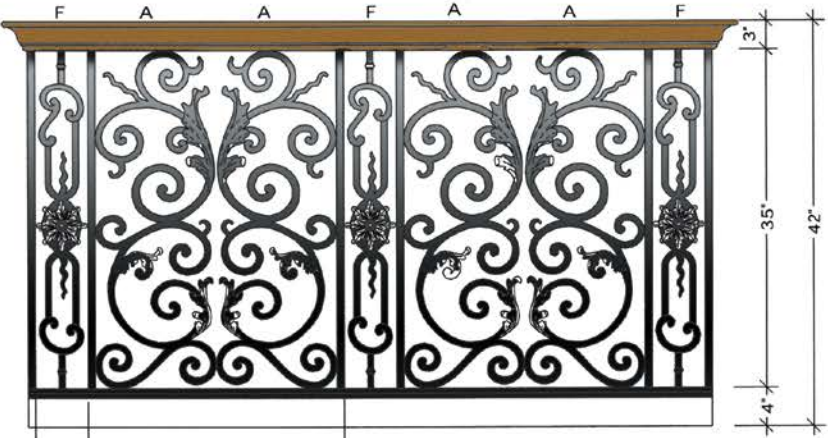

BALCONY  
 3" WOODEN HANDRAIL  
 35" BALUSTER SPACE  
 4" CLOSED STRINGER

WILL CLEAR  
 4" CODE



# BORDEAUX

**PIECE A**  
FITS LEVEL BALCONY OR STRAIGHT RAILS

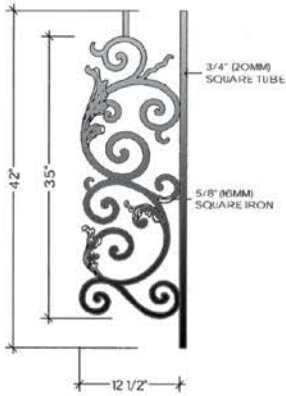

**TOP VIEW**  
A-1 **FLAT**  
**HFBX.A1**

**PIECE B**  
FITS ALL ANGLES UP TO 4 8°

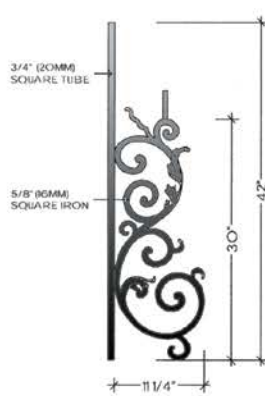

**TOP VIEW**  
B-1 **FLAT**  
**HFBX.B1**

**PIECE B**  
FITS ALL ANGLES UP TO 4 8°

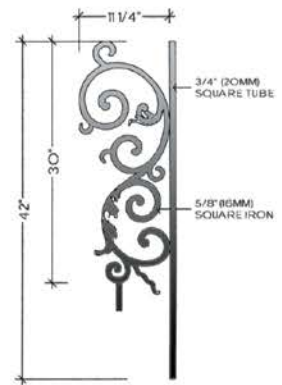

**TOP VIEW**  
B-1 **FLAT**  
**HFBX.B1**

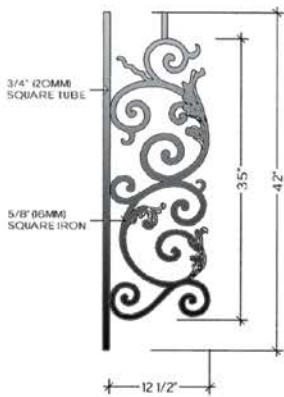

**TOP VIEW**  
A-2  
ALL RADIUS FROM 28" TO 20'-0"  
**HFBX.A2**

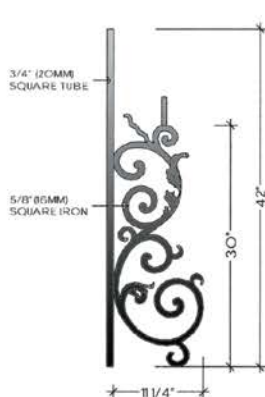

**TOP VIEW**  
B-2  
ALL RADIUS FROM 30" TO 20'-0"  
**HFBX.B2**

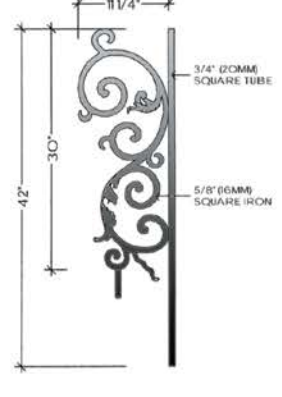

**TOP VIEW**  
B-2  
ALL RADIUS FROM 30" TO 20'-0"  
**HFBX.B2**

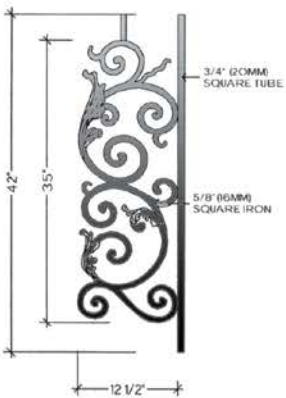

**TOP VIEW**  
A-3  
ALL RADIUS FROM 28" TO 20'-0"  
**HFBX.A3**

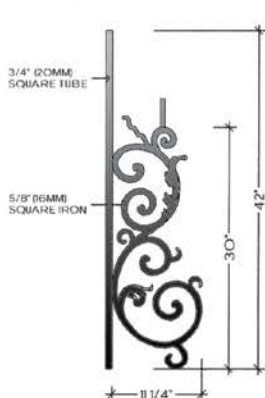

**TOP VIEW**  
B-3  
ALL RADIUS FROM 30" TO 20'-0"  
**HFBX.B3**

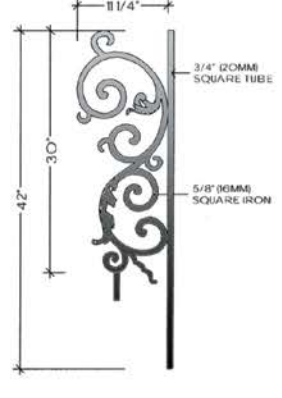

**TOP VIEW**  
B-3  
ALL RADIUS FROM 30" TO 20'-0"  
**HFBX.B3**

# BORDEAUX

**PIECE C**  
FITS ONLY INCLINE ANGLES BELOW 40°

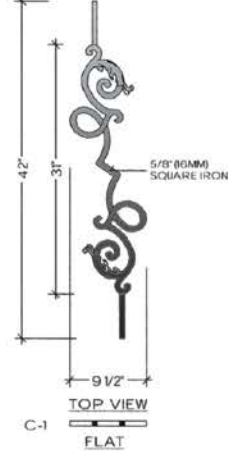

**HFBX.C1**

**PIECE D**  
FITS ALL ANGLES



**HFBX.D**

**PIECE E**  
FITS ONLY ANGLES ABOVE 40°

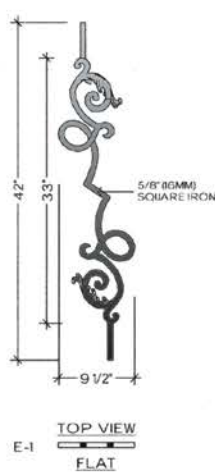

**HFBX.E1**

**RIGHT TERMINATION**  
**INSIDE VIEW**

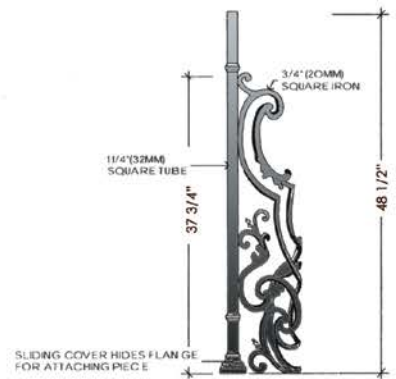

**TOP VIEW**

**HFBX.TERM RT**

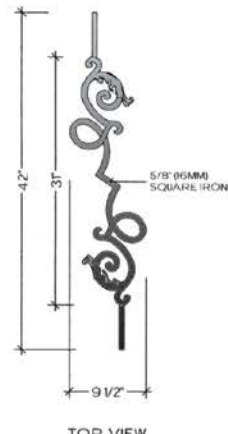

**HFBX.C2**

ALL RADIUS FROM 30° TO 20°: 0°

**PIECE F**  
FITS LEVEL BALCONY OR STRAIGHT RAIL

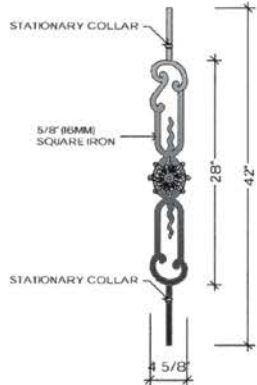

**HFBX.F**

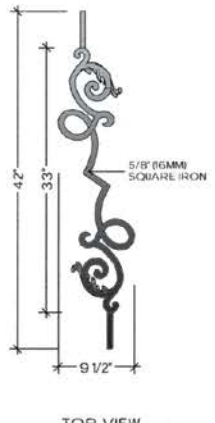

**HFBX.E2**

ALL RADIUS FROM 30° TO 20°: 0°

**LEFT TERMINATION**  
**INSIDE VIEW**

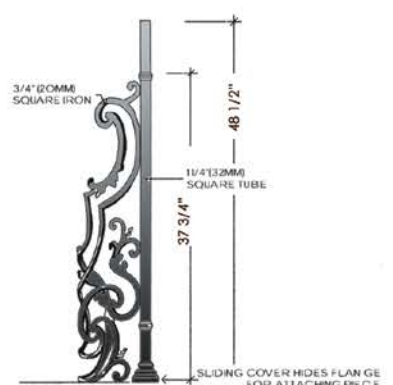

**TOP VIEW**

**HFBX.TERM LF**

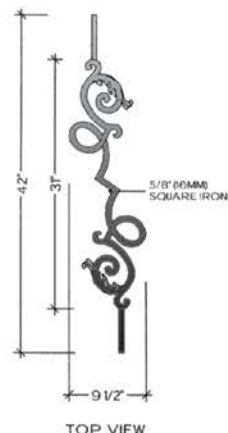

**HFBX.C3**

ALL RADIUS FROM 30° TO 20°: 0°

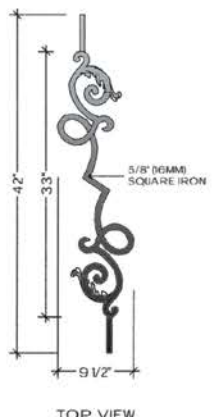

**HFBX.E3**

ALL RADIUS FROM 30° TO 20°: 0°

# REGENCY



Regency HFREA1 (shown)

1" SQUARE  
TUBE



3/8" X 1"  
FLAT IRON

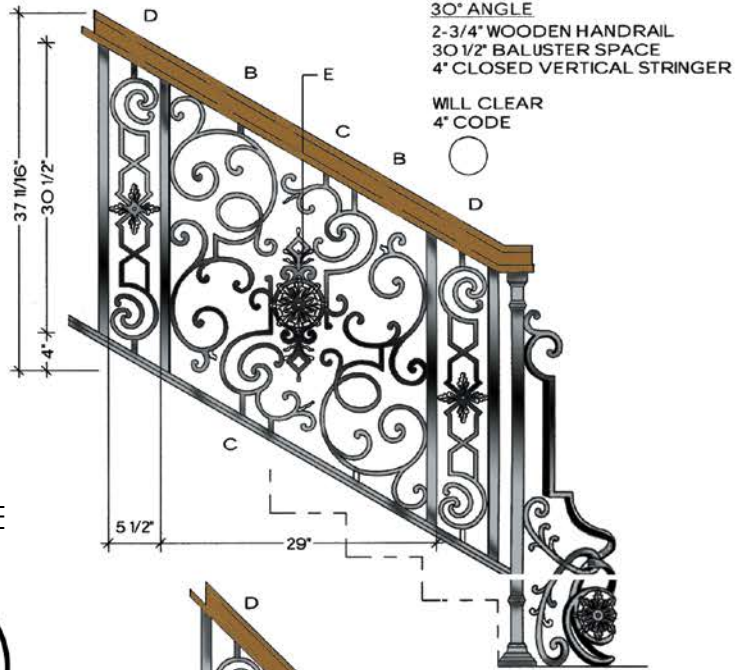

RIGHT REGENCY  
TERMINATION

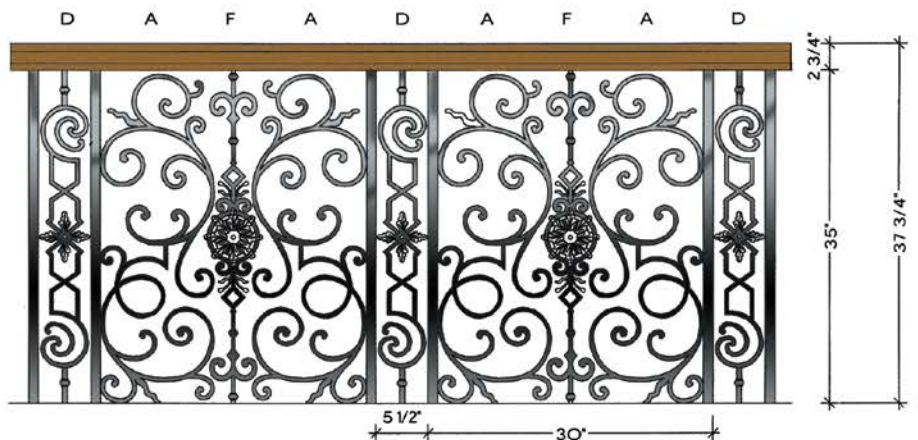
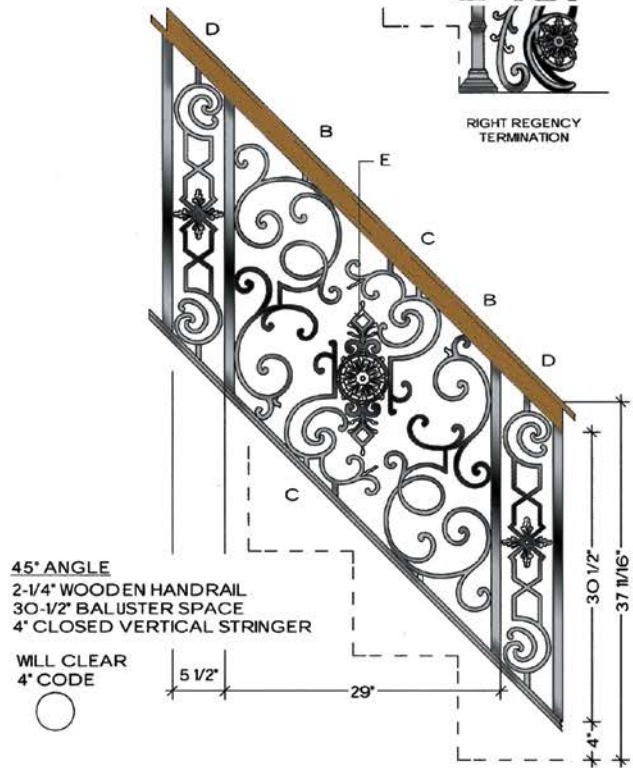

# REGENCY

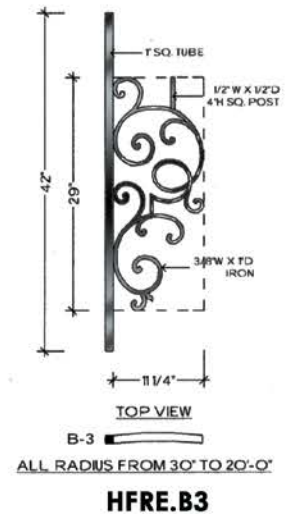
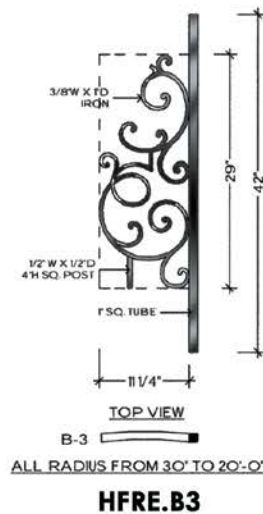
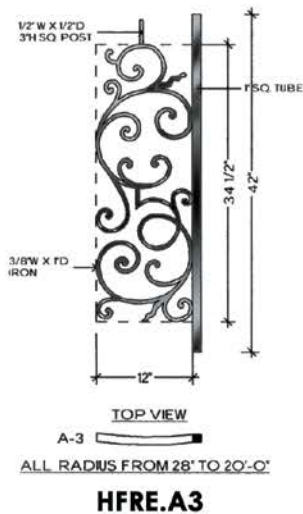
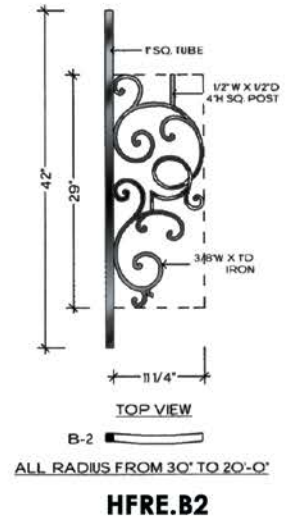
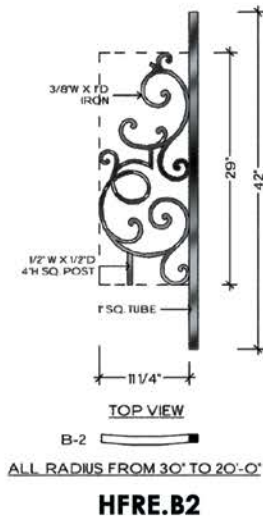
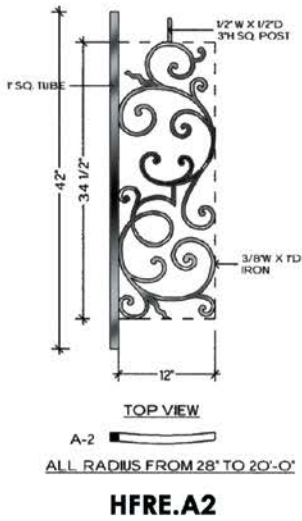
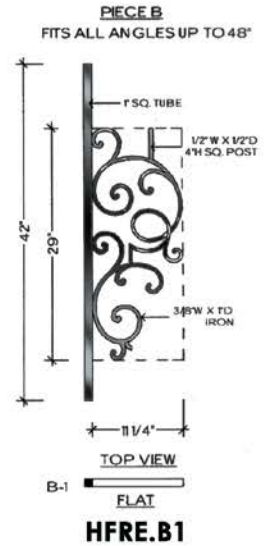
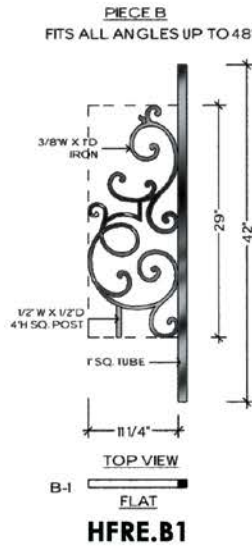
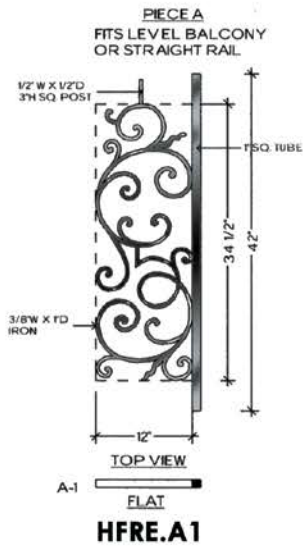

# REGENCY

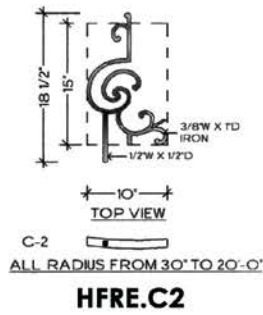
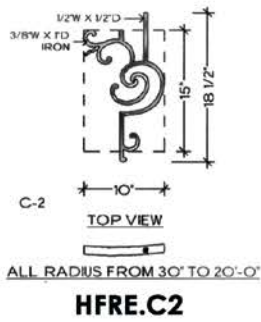
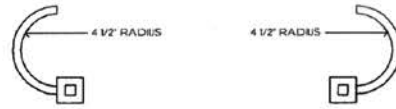
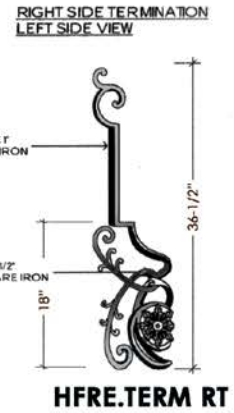
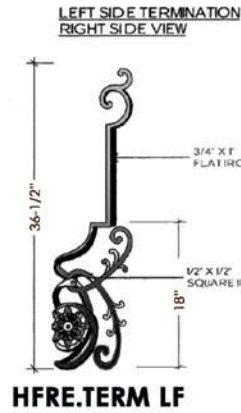
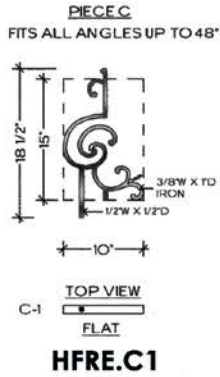
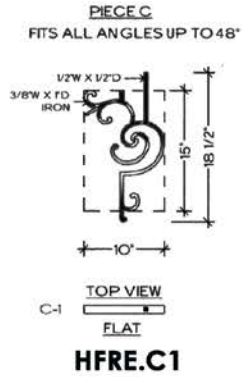

ALL RADIUS FROM 30° TO 20°-0'

ALL RADIUS FROM 30° TO 20°-0'

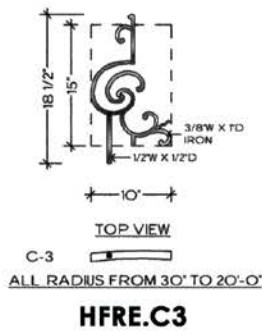
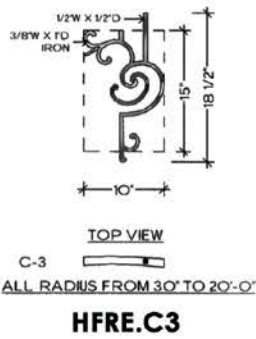

ALL RADIUS FROM 30° TO 20°-0'

ALL RADIUS FROM 30° TO 20°-0'

**TERMINATION**

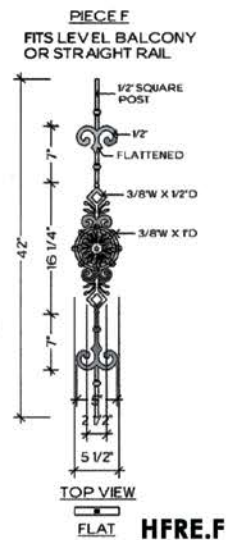
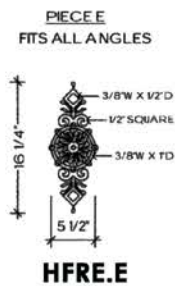
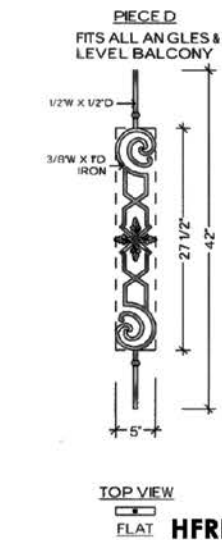
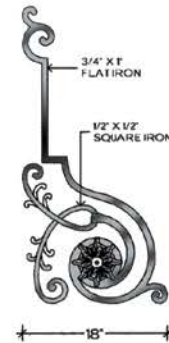



Michelle panels paired with Gothic balusters (shown)

# MICHELLE



Michelle HFMLA1 (shown)

3/8" X 1"  
FLAT IRON



1/4" X 1"  
FLAT IRON

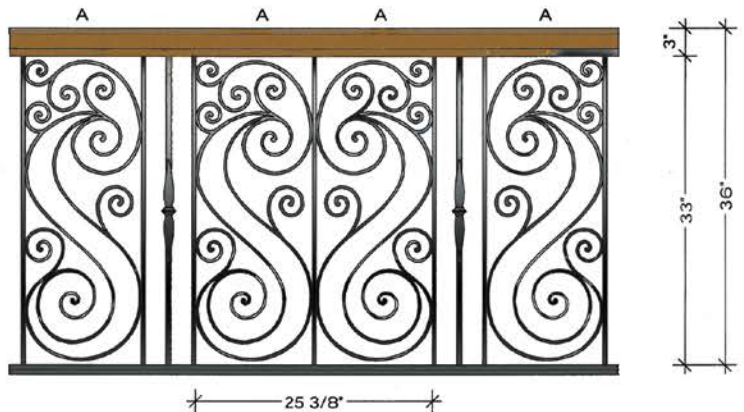
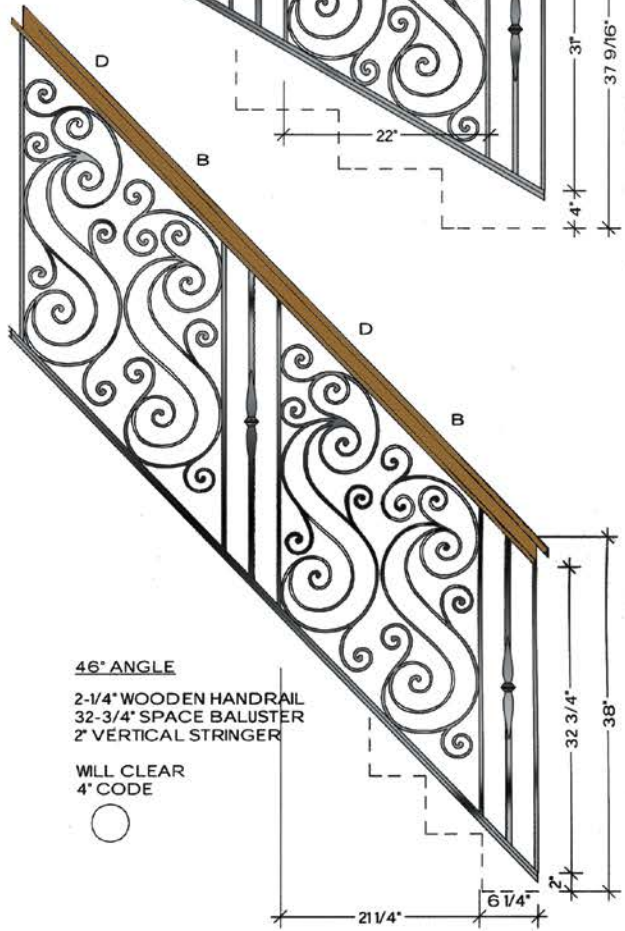
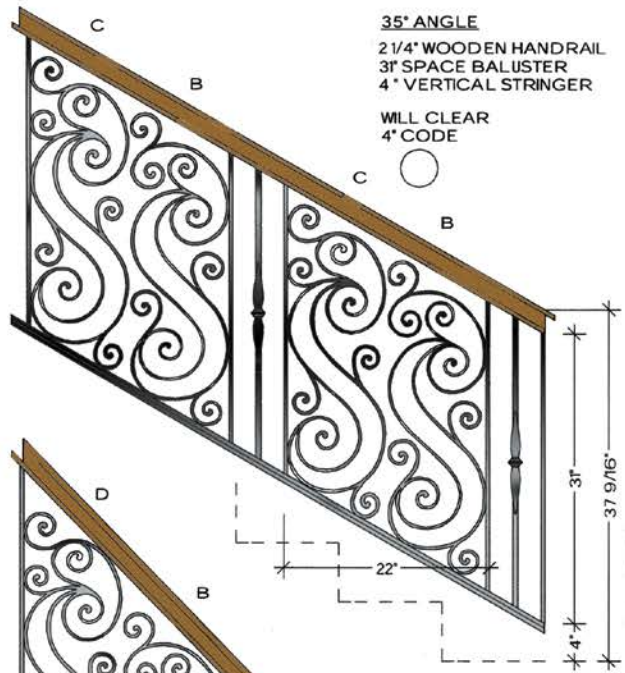

**BALCONY**  
3' WOODEN HANDRAIL  
33' BALUSTER SPACE

WILL CLEAR  
4' CODE



# MICHELLE

**PIECE A**  
FITS LEVEL BALCONY  
OR STRAIGHT RAIL

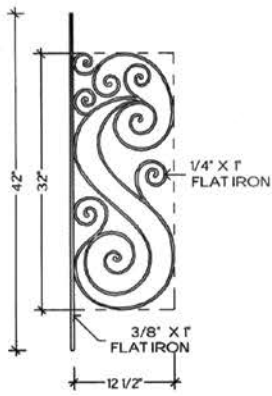

TOP VIEW  
A-1  
FLAT

**HFMI.A1**

**PIECE B**  
FITS ALL ANGLES UP TO 50°

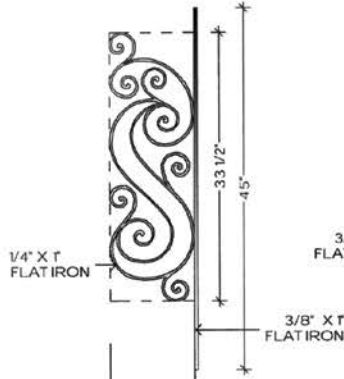

TOP VIEW  
B-1  
FLAT

**HFMI.B1**

**PIECE C**  
FITS ALL ANGLES UP TO 46°

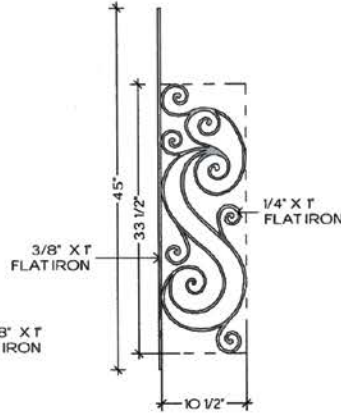

TOP VIEW  
C-1  
FLAT

**HFMI.C1**

**PIECE D**  
FITS ALL ANGLES 47° TO 50°

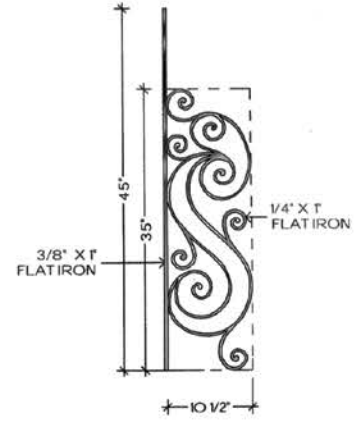

TOP VIEW  
D-1  
FLAT

**HFMI.D1**

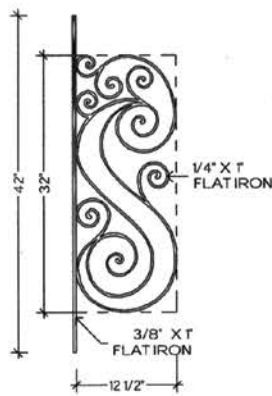

TOP VIEW  
A-2

ALL RADIUS FROM 28" TO 20'-0"

**HFMI.A2**

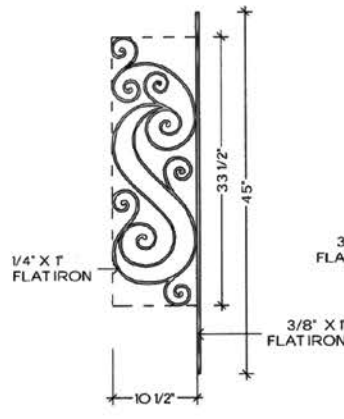

TOP VIEW  
B-2

ALL RADIUS FROM 30" TO 20'-0"

**HFMI.B2**

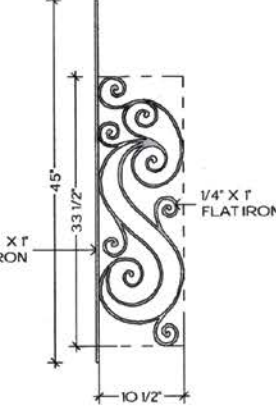

TOP VIEW  
C-2

ALL RADIUS FROM 30" TO 20'-0"

**HFMI.C2**

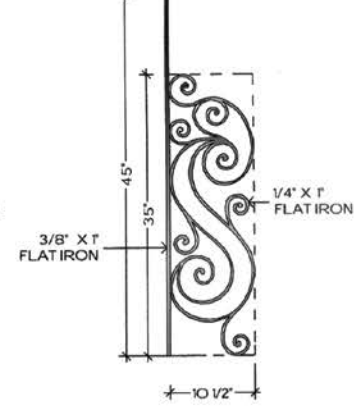

TOP VIEW  
D-2

ALL RADIUS FROM 30" TO 20'-0"

**HFMI.D2**

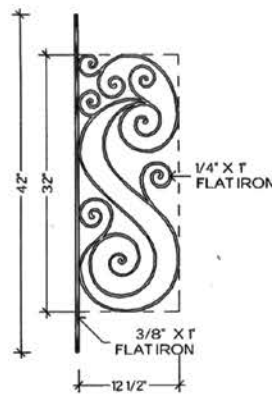

TOP VIEW  
A-3

ALL RADIUS FROM 28" TO 20'-0"

**HFMI.A3**

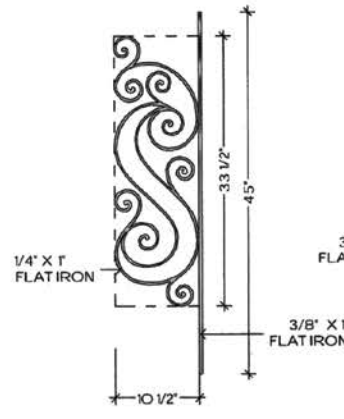

TOP VIEW  
B-3

ALL RADIUS FROM 30" TO 20'-0"

**HFMI.B3**

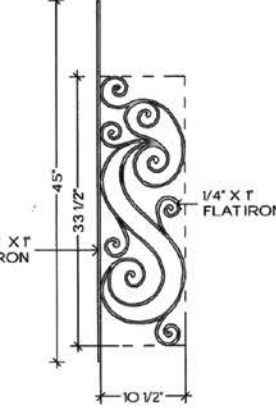

TOP VIEW  
C-3

ALL RADIUS FROM 30" TO 20'-0"

**HFMI.C3**

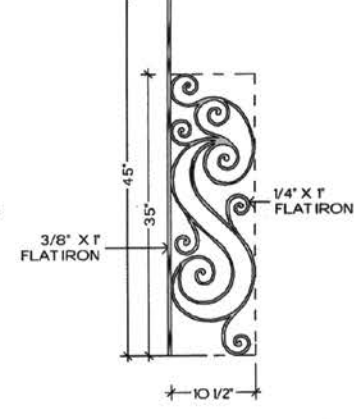

TOP VIEW  
D-3

ALL RADIUS FROM 30" TO 20'-0"

**HFMI.D3**



Classic RO-51 60-6 newels paired with Gothic balusters (shown)

## Wood Products

**At House of Forgings  
we provide much  
more than just forged  
iron products, we  
boast an extensive  
line of wood  
components  
as well.**

From handrails to treads, we carry virtually all components necessary to create the staircase or balcony you have envisioned. All products are stocked in Red Oak or Paint Grade, ready for immediate shipping. Components are packaged and shipped with the utmost integrity ensuring that your order will arrive on time and undamaged.

STAIR & RAILING PRODUCTS BY



**HOUSE OF  
FORGINGS**  
*Reviving the Splendor of Wrought Iron*

# BLANKS



**4000**  
HT. 54"  
W = 3-1/4"



**4005**  
HT. 54"  
W = 3-1/4"



**4007**  
HT. 54"  
W = 3-1/4"



PAINT GRADE  
**4923-41**  
HT. 41"  
W = 1-3/4"  
**4913-41**  
HT. 41"  
W = 1-1/4"

\* RED OAK SPECIAL ORDER



PAINT GRADE  
**5067-36**  
HT. 36"  
W = 1-1/4"  
**5067-39**  
HT. 39"  
W = 1-1/4"  
**5067-41**  
HT. 41"  
W = 1-1/4"

# CLASSIC



**4140**  
HT. 48"  
W = 3"



**4140SP**  
HT. 48"  
W = 3"  
STABILIZER  
NEWEL



**4160**  
HT. 54"  
W = 3"



**4170**  
HT. 54"  
W = 3"



PAINT GRADE  
**4121-41**  
HT. 41"  
W = 1-1/4"

\* SPECIAL ORDER

# CLASSIC



**5140**  
HT. 48"  
W = 3-1/4"



**5160**  
HT. 54"  
W = 3-1/4"  
**5160-4.5**  
HT. 54"  
W = 4-1/2"  
**5160-6**  
HT. 54"  
W = 6"



**5170**  
HT. 54"  
W = 3-1/4"



paint grade  
**4120-41**  
HT. 41"  
W = 1-3/4"



paint grade  
**4220-41**  
HT. 41"  
W = 2-1/4"

\*SPECIAL ORDER

# NEWELS & BALUSTERS

## CLASSIC-FLUTED



## REMINGTON



## REMINGTON



\*SPECIAL ORDER

All newels stocked in Red Oak (RO), all balusters stocked in primed white Paint Grade (PG)



Magnolia RO-4042-4 newels paired with Twist/Scroll balusters (shown)

# NUEVO



**4444-TW**  
HT. 48"  
W = 3-1/2"



**4442-TW**  
HT. 54"  
W = 3-1/2"



paint grade  
**5415-41-TW**  
HT. 41"  
W = 1-3/4"

\*SPECIAL ORDER

# MAGNOLIA



**4010-48**  
HT. 48"  
W = 3"

**4010-3.5**  
HT. 48"  
W = 3-1/2"



**4010SP**  
HT. 48"  
W = 3"



**4040**  
HT. 48"  
W = 3"

**4042**  
HT. 54"  
W = 3"

**4042-3.5**  
HT. 54"  
W = 3-1/2"

**4042-4.0**  
HT. 54"  
W = 4"



**4045**  
HT. 54"  
W = 3"

**4045-3.5**  
HT. 54"  
W = 3-1/2"



paint grade  
**5015-36**  
HT. 36"  
W = 1-1/4"

**5015-39**  
HT. 39"  
W = 1-1/4"

**5015-41**  
HT. 41"  
W = 1-1/4"

**5015-43**  
HT. 43"  
W = 1-1/4"

# CONCORD



**4315**  
HT. 48"  
W = 3"

**4275**  
HT. 54"  
W = 3-1/4"



**4301**  
HT. 54"  
W = 3"

**4501**  
HT. 54"  
W = 3-1/4"



**4305**  
HT. 54"  
W = 3"

**4505**  
HT. 54"  
W = 3-1/4"



**4270-SP**  
HT. 54"  
W = 3-1/4"  
STABILIZER  
NEWEL



paint grade  
**4625-41**  
HT. 41"  
W = 1-3/4"



paint grade  
**4611-41**  
HT. 41"  
W = 1-3/4"

ELEGANTE-COLUMN



**4480**  
HT. 56"  
W = 5-1/2"



**4485-5**  
HT. 56"  
W = 3-1/4"



**4485**  
HT. 48"  
W = 3-1/4"

ELEGANTE-TWIST



**4440**  
HT. 56"  
W = 5-1/2"



**4450-5**  
HT. 56"  
W = 3-1/4"



**4450**  
HT. 48"  
W = 3-1/4"

All Elegante newels and balusters stocked in Red Oak (RO)

BOX NEWELS



Contemporary  
Box Newel  
**4191**  
HT. 56-1/2"  
W = 3-1/4"



Plain Box  
Newel  
**961-56**  
HT. 56"  
W = 4-1/2"



Recessed Panel  
Box Newel  
**4291**  
HT. 52"  
W = 6"



All box newels come with both square and pyramid tops

BOX NEWELS



Adjustable  
Box Newel  
**4592**  
HT. 54"  
W = 5"  
Plain Box  
Newel  
**4691**  
HT. 56"  
W = 6-1/4"



Raised Panel  
Box Newel  
**4791**  
HT. 56"  
W = 6-1/4"



Fluted Box  
Newel  
**4891**  
HT. 56"  
W = 6-1/4"



Recessed Panel  
Box Newel  
**4991**  
HT. 60"  
W = 6-1/4"

All box newels stocked in Red Oak (RO)





Elegante-Column newels (RO-4480/RO-4485)  
paired with Twist/Scroll balusters (shown)



Elegante-Twist newels (RO-4440) paired with Tuscan balusters/Bordeaux panels (shown)



Box newels (RO-4891) paired with Versatile balusters (shown)

# HANDRAIL & FITTINGS

**6040**



**6040**  
Round Wall Rail  
Diameter: 1-5/8"

## RETURNED END



-  7009
-  7209
-  7709

**6010**



Colonial Hand Rail  
HT. 2-3/8"  
W. 2-1/4"

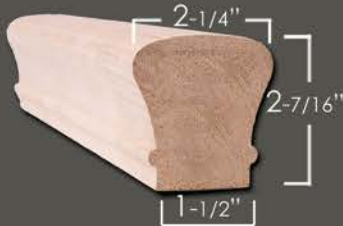

**6010** Straight Rail  
**6010-B** Bending Rail  
bending rail includes moulding

## OPENING CAP



-  7019
-  7219
-  7719

**6210**



Traditional Hand Rail  
HT. 2-3/8"  
W. 2-5/8"



**6210** Straight Rail  
**6210-B** Bending Rail  
bending rail includes moulding

## TANDEM CAP



-  7020
-  7220
-  7720

**6710**



Prestige Hand Rail  
HT. 2-3/4"  
W. 2-5/8"

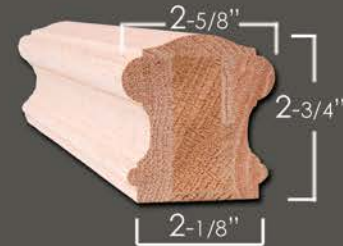

**6710** Straight Rail  
**6713** Bending Rail  
bending rail includes moulding

## OVER EASING



-  7013
-  7213
-  7713

## UP EASING 90 DEGREE



-  7012
-  7212
-  7712
-  7014
-  7214
-  7714



## START EASING WITH CAP



-  7010
-  7210
-  7710

All handrail and fittings stocked in Red Oak (RO)



-  7011
-  7211
-  7711



-  7021
-  7221
-  7721



- | LEFT HAND  | RIGHT HAND   |
|--|--|
|  7040 |  7045 |
|  7240 |  7245 |
|  7740 |  7745 |



-  7099
-  7299
-  7799

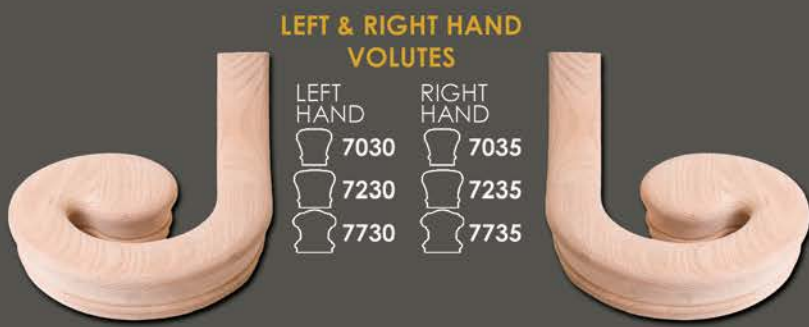

- | LEFT HAND  | RIGHT HAND   |
|--|--|
|  7030 |  7035 |
|  7230 |  7235 |
|  7730 |  7735 |



-  7088-2
-  7288-2
-  7788-2



- | LEFT HAND  | RIGHT HAND   |
|--|--|
|  7071 |  7076 |
|  7271 |  7276 |
|  7771 |  7776 |



- | LEFT HAND  | RIGHT HAND   |
|--|--|
|  7081 |  7086 |
|  7281 |  7286 |
|  7781 |  7786 |

All handrail and fillings stocked in Red Oak (RO)

# TREADS/STEPS/LUMBER/PLY

## TREADS

### RO-8070

Red Oak Bull Nose Tread  
1-1/16" x 11-1/2" x 42, 48, 54,  
60, 72, 84, 96, 108"



## DOUBLE END STARTING STEP

Diameter: 13-3/4"

- 8015-42** (42" throat) (66" overall)
- 8015-44** (44" throat) (68" overall)
- 8015-48** (48" throat) (72" overall)
- 8015-52** (52" throat) (76" overall)
- 8015-54** (54" throat) (78" overall)
- 8015-60** (60" throat) (84" overall)
- 8015-72** (72" throat) (96" overall)

Red Oak(RO), Maple(ME)

## CLASSIC TREADS

### RO-8070-13 x

Red Oak Tread  
1-1/16" x 13" x 48, 60, 72, 96, 108"

### RO-8070-18 x

Red Oak Tread  
1-1/16" x 18" x 48, 60, 72, 84, 96"

### RO-8070-20 x 60

Red Oak Tread  
1-1/16" x 20" x 60"

### RO-8070-20 x 72

Red Oak Tread  
1-1/16" x 20" x 72"

### RO-8070-24 x

Red Oak Tread  
1-1/16" x 24" x 60", 72", 84", 96", 120"

### RO-8070-48 x 48

Red Oak Tread  
1-1/16" x 48" x 48"

### RO-8070-60 x 60

Red Oak Tread  
1-1/16" x 48" x 48"

### RO-8070-48-MR

1-1/16" x 11-1/2" x 48"

### RO-8070-54-MR

1-1/16" x 11-1/2" x 54"

### RO-8070-60-MR

1-1/16" x 11-1/2" x 60"

Mitered Return(MR)(Reversible)

Overall length does not include mitered return

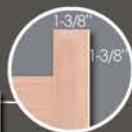

## SINGLE END STARTING STEP

Diameter: 13-3/4"

- 8010-48** (48" throat) (60" overall)
- 8010-60** (60" throat) (72" overall)
- 8010-72** (72" throat) (84" overall)

Red Oak(RO), Maple(ME)

## SPECIAL WEDGE SHAPED DOUBLE END STARTING STEP

Diameter: 12-3/4" (small end)

Diameter: 18-1/2" (large end)

**RO-8915-48** (48" throat) (73-1/2" overall)

**RO-8915-54** (54" throat) (79-1/2" overall)

(Reversible)

Red Oak(RO), Maple(ME)

## FALSE END STARTING STEP

Diameter: 13-3/4"

Length: 17-5/8" overall

**8011**

Diameter: 17-1/2"

Length: 21-3/4" overall

**8012**

Red Oak(RO), Maple(ME), Poplar(PR)

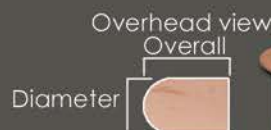

## STARTER STEP VENEER

Width: 8"

Length: 120"

**RO-VENEER** (Red Oak)

**ME-VENEER** (Maple)

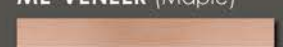

## BULL NOSED LANDING TREAD

### 8090-6

RED OAK

### 8090-6B

RED OAK BENDING(26 pieces)

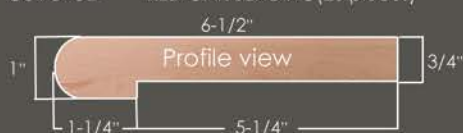

## 1" BULL NOSING

### 8080

RED OAK

### 8080-B

RED OAK BENDING (5 pieces)



## TONGUE & GROOVED

## BULL NOSED LANDING TREAD

### 8090-6-G

RED OAK(grooved)



## TONGUE & GROOVED LUMBER

### 8095-8-T&G

RED OAK (tongue & grooved)



### 8095-12-T&G

RED OAK (tongue & grooved)



## LUMBER

### RO-06

Red Oak 3/4" x 5-1/2" S4S Lumber

### RO-08

Red Oak 3/4" x 7-1/4" S4S Lumber

### RO-08-B

Red Oak 3/4" x 7-1/4" Bending(29 pieces)

### RO-12

Red Oak 3/4" x 11-1/4" S4S Lumber

### MDF-06

MDF 11/16" x 5-1/4"

### MDF-08

MDF 11/16" x 7-1/4"

### MDF-12

MDF 11/16" x 11-1/4"

## PLYWOOD

### PLY-1/4-MDF

MDF 1/4" x 4' x 8' Half Sheet 1/4" x 2' x 8'

### PLY-3/4-MDF

MDF 3/4" x 4' x 8'

### PLY-1/8-RO

Red Oak 1/8" x 4' x 8' Half Sheet 1/4" x 2' x 8'

### PLY-1/4-RO

Red Oak 1/4" x 4' x 8' Half Sheet 1/4" x 2' x 8'

### PLY-1/2-RO

Red Oak 1/2" x 4' x 8'

### PLY-3/4-RO

Red Oak 3/4" x 4' x 8'

### PLY-3/4-RO-10

Red Oak 3/4" x 4' x 10'

### PLY-1/8-Birch

Birch 1/8" x 4' x 8'

### PLY-1/4-Birch

Birch 1/4" x 4' x 8' Half Sheet 1/4" x 2' x 8'

### PLY-1/2-Birch

Birch 1/2" x 4' x 8'

### PLY-3/4-Birch

Birch 3/4" x 4' x 8'

### PLY-3/8-Bending

Red Oak 3/8" x 4' x 8' (bending board)



Elegante-Column newels (RO-4480/RO-4485) paired with Tuscan balusters. Special wedge shaped double end starting step (shown)

# WOOD MOULDING & FLEXIBLE TRIM



<b>RO-C8</b>	Red Oak 2-1/2" x 11/16" Colonial Casing
<b>PG-C8</b>	Paint Grade 2-1/2" x 11/16" Colonial Casing
<b>FLEX-C8</b>	Paint Grade 2-1/2" x 11/16" Colonial Casing



<b>RO-CAP MOULD</b>	Red Oak 1-1/8" x 3/8" Cap Mould
<b>PG-CAP MOULD</b>	Paint Grade 1-1/8" x 3/8" Cap Mould



<b>RO-6007</b>	Red Oak 1-3/4" Filet
<b>PG-6007</b>	Paint Grade 1-3/4" Filet



<b>RO-6050</b>	Red Oak 1-1/4" Filet
<b>PG-6050</b>	Paint Grade 1-1/4" Filet



<b>RO-PM-1</b>	Red Oak 11/16" x 1/-1/4" RAB. Panel Mould
<b>PG-PM-1</b>	Paint Grade 11/16" x 1/-1/4" RAB. Panel Mould
<b>Flex-PM-1</b>	Flexible Smooth 11/16" x 1/-1/4" RAB. Panel Mould
<b>Flex-PM-1-WG</b>	Flexible Wood Grain 11/16" x 1/-1/4" RAB. Panel Mould (1/4" Offset)



<b>RO-PM-2</b>	Red Oak 11/16" x 1/-1/4" RAB. Panel Mould
<b>PG-PM-2</b>	Paint Grade 11/16" x 1/-1/4" RAB. Panel Mould
<b>Flex-PM-2</b>	Flexible Smooth 11/16" x 1/-1/4" RAB. Panel Mould
<b>Flex-PM-2-WG</b>	Flexible Wood Grain 11/16" x 1/-1/4" RAB. Panel Mould (3/4" Offset)



<b>RO-PM-5</b>	Red Oak 11/16" x 1-1/8" Flat Panel Mould
<b>PG-PM-5</b>	Paint Grade 11/16" x 1-1/8" Flat Panel Mould
<b>Flex-PM-5</b>	Flexible Smooth 11/16" x 1-1/8" Flat Panel Mould
<b>Flex-PM-5-WG</b>	Flexible Wood Grain 11/16" x 1-1/8" Flat Panel Mould



<b>RO-8050</b>	Red Oak 7/16" x 3/4" Base Shoe Mould
<b>Flex-MS-127</b>	Flexible Smooth 7/16" x 3/4" Base Shoe Mould
<b>Flex-MS-127-WG</b>	Flexible Wood Grain 7/16" x 3/4" Base Shoe Mould



<b>RO-8060</b>	Red Oak 3/4" x 7/8" Cove Mould
<b>PG-8060</b>	Paint Grade 3/4" x 7/8" Cove Mould
<b>Flex-MS-92</b>	Flexible Smooth 3/4" x 7/8" Cove Mould
<b>Flex-MS-92-WG</b>	Flexible Wood Grain 3/4" x 7/8" Cove Mould



<b>RO-8065</b>	Red Oak 1/2" x 1/2" Cove Mould
<b>PG-8065</b>	Paint Grade 1/2" x 1/2" Cove Mould
<b>Flex-MS-101</b>	Flexible Smooth 1/2" x 1/2" Cove Mould
<b>Flex-MS-101-WG</b>	Flexible Wood Grain 1/2" x 1/2" Cove Mould



<b>Flex-LS-105</b>	Flexible Smooth 3/4" x 3/4" Quarter Round Mould
<b>Flex-LS-105-WG</b>	Flexible Wood Grain 3/4" x 3/4" Quarter Round Mould



# ACCESSORIES

## WALL RAIL BRACKET

1-1/4" x 2-3/8" Mounting Plate  
3" Extension From Wall  
(Used with 6040 Round Wall Rail)



- HFBC.3002 (BRUSHED CHROME)
- HFCV.3002 (COPPER VEIN)
- HFORB.3002 (OIL RUBBED BRONZE)
- HFORC.3002 (OIL RUBBED COPPER)
- HFPB.3002 (POLISHED BRASS)
- HFSC.3002 (SATIN CLEAR)
- HFSP.3002 (SILVER VEIN)
- HFSTB.3002 (SATIN BLACK)
- HFVB.3002 (VINTAGE BRASS)

## HANDRAIL BRACKET

2-1/16" Rd. Mounting Plate  
3" Extension From Wall  
(Used with 6010, 6210, 6710 Hand Rail)



- HFBC.3003 (BRUSHED CHROME)
- HFAN.3003 (ANTIQUE NICKEL)
- HFCE.3003 (CHROME)
- HFNL.3003 (NICKEL)
- HFCV.3003 (COPPER VEIN)
- HFORB.3003 (OIL RUBBED BRONZE)
- HFORC.3003 (OIL RUBBED COPPER)
- HFPB.3003 (POLISHED BRASS)
- HFSC.3003 (SATIN CLEAR)
- HFSP.3003 (SILVER VEIN)
- HFSTB.3003 (SATIN BLACK)
- HFVB.3003 (VINTAGE BRASS)

## WOOD GLUE & FILLER



**S-9202** (1 Gal.)  
**S-9203** (32 oz.)  
**S-9204** (16 oz.)  
**FAM-O-WOOD**  
**RO-9208** (Red Oak)

## EPOXY GUN-EPC-112



## EPOXY-EPC-410



## EPOXY PASTE EPC-7



## OAK PLUGS



- RO-3003 (1-1/2")
- RO-3000 (1-1/4")
- RO-3001 (1")
- RO-3002 (3/4")
- RO-9010 (5/8")
- RO-9004 (1/2")
- RO-9005 (3/8")

## OAK ROSETTES

**RO-7037**  
4" x 5-1/2" (Red Oak)



## NEWEL FASTENER

**S-9403**

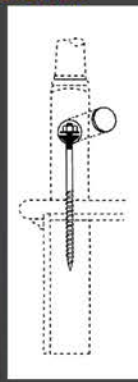

Sure Tite

## NEWEL FASTENER

**S-9401**

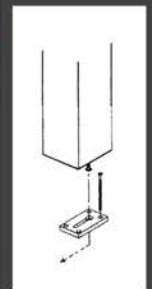

Key Lock

## RAIL BOLT KIT

**S-9600**  
(Includes hex nut, spacer and 1" Red Oak plug)



## RAIL BOLT DRIVER

**S-9600-D**  
(driver sold individually)



## DOWEL & SCREW DRIVER

**C-905-2D** (Sold Individually)

**C-905-2** (25 per bag)





Maple Poplar White Oak

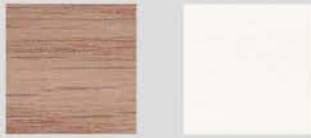

Red Oak (RO) Paint Grade (PG)  
*Primed White*



Hickory/Pecan Clear Alder American Cherry



Walnut Sapele Mahogany Brazilian Cherry

## Wood Products

All wood products are stocked in Red Oak (RO) or Paint Grade (PG) unless otherwise noted.

## Domestic and Exotic Wood Species

All wood products in non-stock species are available by special order.



## Marketing Literature

We offer a wide array of marketing literature designed to support product sales: product catalogs, brochures, flyers, postcards and customized literature are available through our authorized dealer program.



## Sales Displays

Our wide variety of sales displays will provide you with the tools to sell products. We have sizes to fit your floor space. Custom displays are also available.

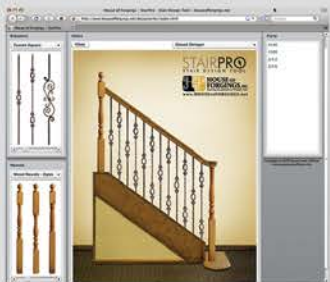

## Software & Design

StairPro web-based stair design tool makes it easy to plan your staircase project. Our extensive library of CAD images and product photos will aid and inspire you in designing your staircase.

## Training

We offer extensive product training to give you the knowledge necessary to sell our full line of products. Inquire with your sales representative today.



## AUTHORIZED DEALER



YOUR STAIR & RAILING CO.

### HOUSTON

16684 Air Center Blvd.  
Houston, TX 77032

P: 281.209.0000  
F: 281.209.0067  
[ironwoodusa.com](http://ironwoodusa.com)

### AUSTIN

8606 Wall St. Suite 200  
Austin, TX 78754

P: 512.973.8373  
F: 512.973.9919  
[ironwoodaustin.com](http://ironwoodaustin.com)

### SAN ANTONIO

P: 210.521.4808  
F: 210.521.7618

[ironwoodsanantonio.com](http://ironwoodsanantonio.com)

### DALLAS-FORT WORTH

2520 N Great Southwest Pkwy.  
Suite 104  
Grand Prairie, TX 75050

P: 817.701.2006  
F: 817.701.2020  
[ironwooddfw.com](http://ironwooddfw.com)

STAIR & RAILING PRODUCTS BY

